

# **ASSEMBLING**

**the**

# **ECEbot**

## ***Printed Circuit Board: Part One***

### **Due Date**

The Part One assembly steps must be completed prior to: \_\_\_\_\_

Prepared by R.C. Maher  
October 2008

Copyright © 2008 Department of Electrical and Computer Engineering, Montana State University  
All Rights Reserved

**BEFORE STARTING:** be sure to put your name on your kit box! Also be sure to label your robot PCB with a marker pen. This will help get the items returned if they are lost or misplaced.

## 1 Printed Circuit Board Preliminaries

This section describes the initial steps to begin soldering the ECEbot's circuit board. Look at both sides of the Printed Circuit Board (PCB). The front side has printed lines and labels called the "silk screen," while the back side doesn't have any printing on it. Notice that there are many small labels on the front (silk screen) side of the board. The instructions will often refer to the components by these labels, like diode "LED3", resistor "R11", or header "J17". Most of the components will be inserted in the board from the front side by slipping the wires or legs through the drill holes, then soldering them to the back side.

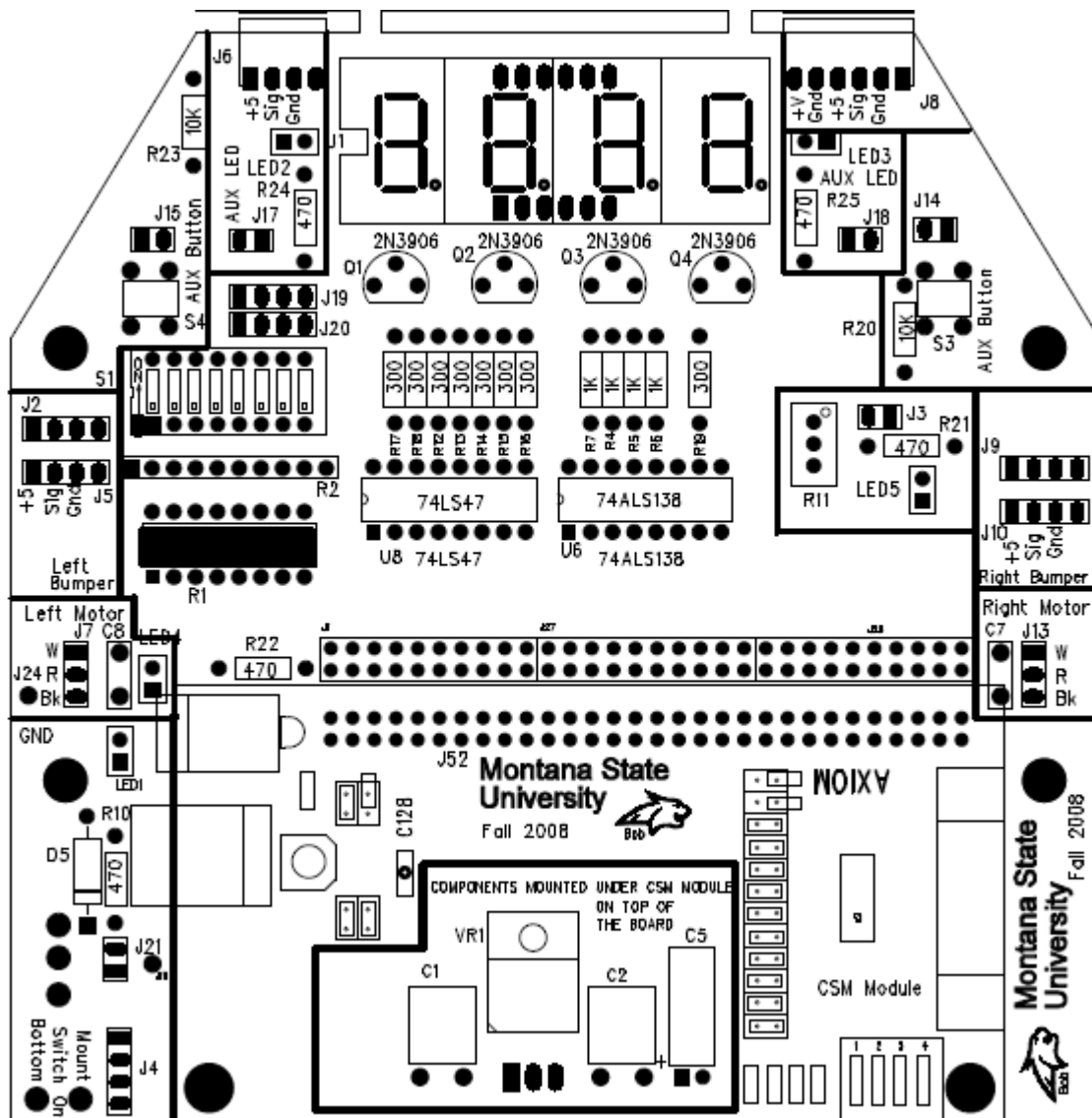

Figure 1-1: PCB Layout: Front of Main Board

The assembly and soldering steps are quite intricate and you must keep alert to avoid placing the components incorrectly: be sure to double-check each step before doing the assembly. The instructions include a “stop sign” whenever there is a particularly important set of instructions:



### 1.1 Separating the header pins



Many of the electrical signals on the PCB will appear on a *header*, or a row of vertical needle-like pins. Find the three sets of 36-pin headers in your parts kit.

Only a few header pins are needed this week, but it makes sense to go ahead and break the 36-pin sets into the smaller segments that are needed later. Clip the 36-pin header strips into the following groups by carefully snapping or cutting between the pins. **Be sure to hold all of the pieces as you separate the sections so that nothing pops off into your eye.**



- Set 1: 30, 4, 2
- Set 2: 30, 4, 2
- Set 3: 6, 4, 4, 3, 3, 2, 2, 2, 2, 1, 1, plus spares

You should now have: 2@30, 1@6, 4@4, 2@3, 6@2, and 2@1. Place all of the separated header pieces into a container in your lab kit for later.

### 1.2 Separating the PCB sections

The main robot components consist of three separate boards, but for ease of manufacture the boards are produced as one connected piece. Carefully flex the board to snap and separate the sections: main board, bumper switch board, and the chassis board. You may want to file the rough edges or smooth the corners with a hobby knife.

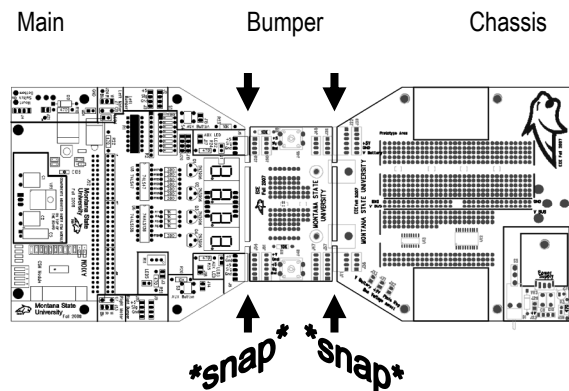

Identify the main board (Figure 1-1) and place the other two boards in your lab kit for later use.

### 1.3 Soldering Step 2: Installing the Discrete Resistors

Do not proceed until the instructor has demonstrated how to use the soldering iron and you have practiced making several solder joints using one of the scrap circuit boards in the lab.

There are 19 individual resistors that need to be soldered in place on the main PCB.

Locate the following discrete resistors in your parts kit:

Qty	Resistor Type	Color Bands	Position on PCB
8	300 $\Omega$ , 5%, 1/4 W (small)	Orange Black Brown Gold	R12, R13, R14, R15, R16, R17, R18, R19
5	470 $\Omega$ , 5%, 1/4 W	Yellow Violet Brown Gold	R10, R21, R22, R24, R25
4	1 k $\Omega$ , 5%, 1/4 W	Brown Black Red Gold	R4, R5, R6, R7
4	10 k $\Omega$ , 5%, 1/4 W	Brown Black Orange Gold	R20, R23 (and R8 and R9 for bumpers)

There are several different resistances (ohms) that are used, so be careful to verify the correct value resistor is in the proper mounting position.

*Hint: It is a good idea to place the resistors so that the color code bands start at the top of the board. The resistor is not a polarized component so it would work in either orientation, but keeping all the bands in the same direction makes it easier to verify the circuit or to find errors later on—and it also makes for a neat, tidy, and professional looking assembly.*

To start, hold the board with the front side up and oriented so that you can read the printed silk screen labels from top to bottom, like in Figure 1-1. Select one of the 10 k $\Omega$  resistors and locate position **R23** near the upper left corner of the PCB.

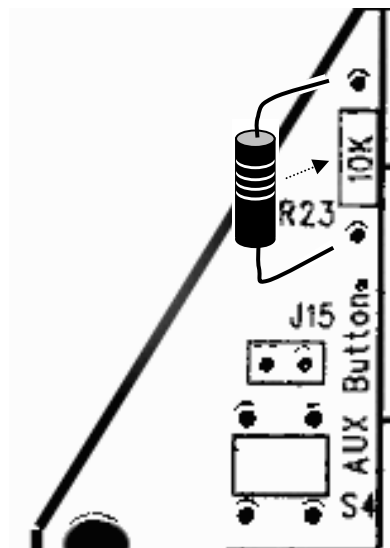

*Carefully* bend the wire leads and insert the ends from the front of the board through the proper pair of holes. It is always wise to double-check the component and its placement before soldering, since removing soldered parts is not easy and often results in damage to the board and to the component. The resistors and other passive components should not be soldered precisely flush with the board: leave a small gap between the component and the board.

*Hint: Once the component leads are through the board, bend the ends slightly on the back side of the board so that the component won't slide out of the holes when you flip the board over.*

→ Flip the board to the back side and solder the two wire leads of the resistor to the pads on the back side.

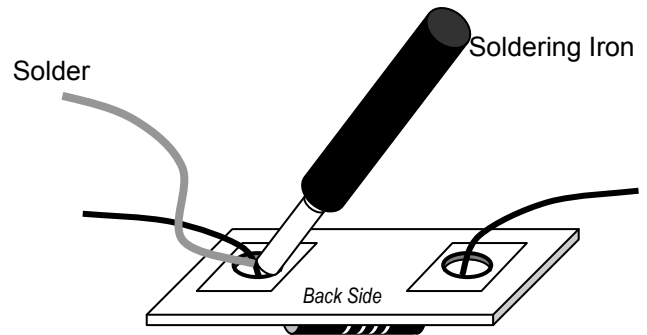

Only use enough heat and solder to make a clean, shiny, and uniform joint that fills each pad but does not seep over to touch any of the adjacent pads. The solder joint should look like a tiny wrapped Hershey's Kiss candy. Have your instructor or TA look at your soldered component and approve your technique before continuing.

After the solder cools, *gently* clip off the excess wires on the back side just above each solder joint: be sure to hold the wire so it doesn't go shooting across the room as you clip it!

→ Now locate the proper place for each of the 18 other resistors and systematically solder them in place. If you are in doubt about where a resistor goes, be sure to ask the instructor or lab TA for assistance.

### 1.4 Soldering Step 3: Attach the 60-pin Socket

Hold the board with the front side up. The row of holes just above the silk screen label "Montana State" (J52 label) is the location of the 60-pin socket that will hold the microcontroller board. A socket provides electrical connections to another component and aids in removing and replacing that component if necessary.

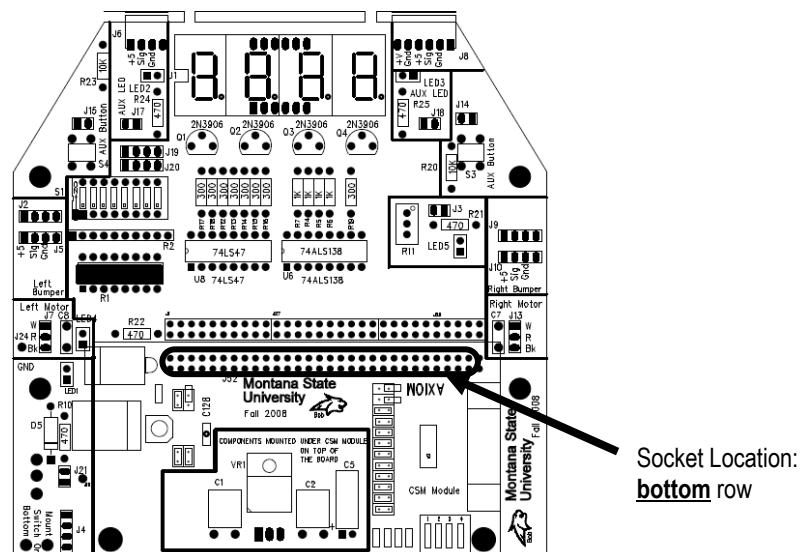
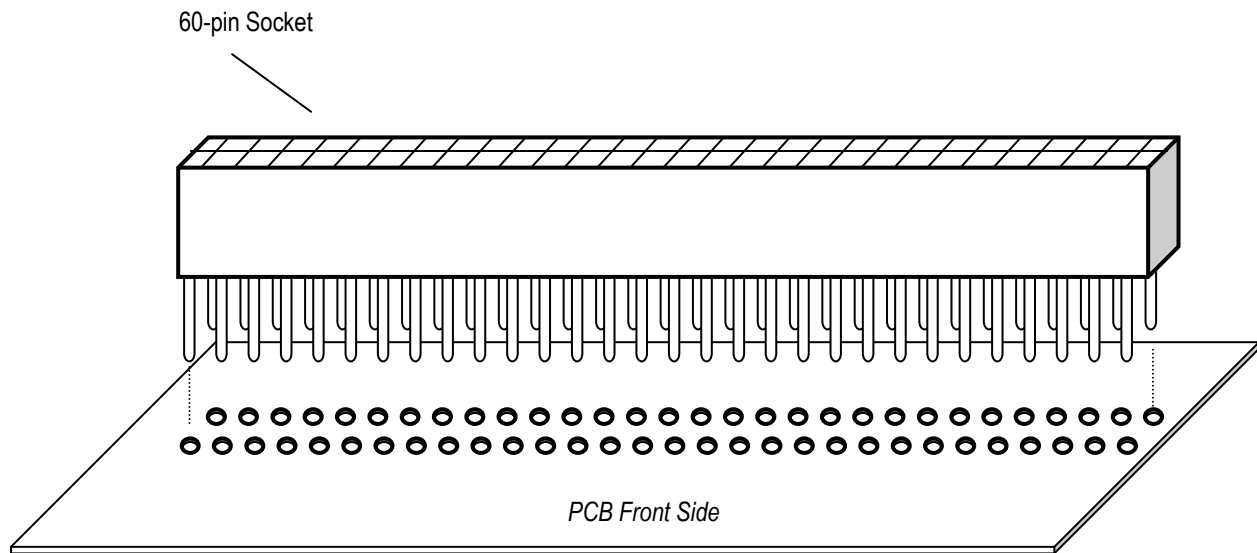

Figure 1-2: Socket location and orientation on the PCB

Find the 60-pin socket in your lab kit. Carefully line up all 60 pins of the socket with the holes on the PCB (see Figure 1-3) and hold the socket flush against the board as you flip it over.



**Figure 1-3: Placing the 60-pin socket onto the PCB**

Once flipped over, you should now see the 60 pins protruding from the holes on the back side of the board (Figure 1-4).

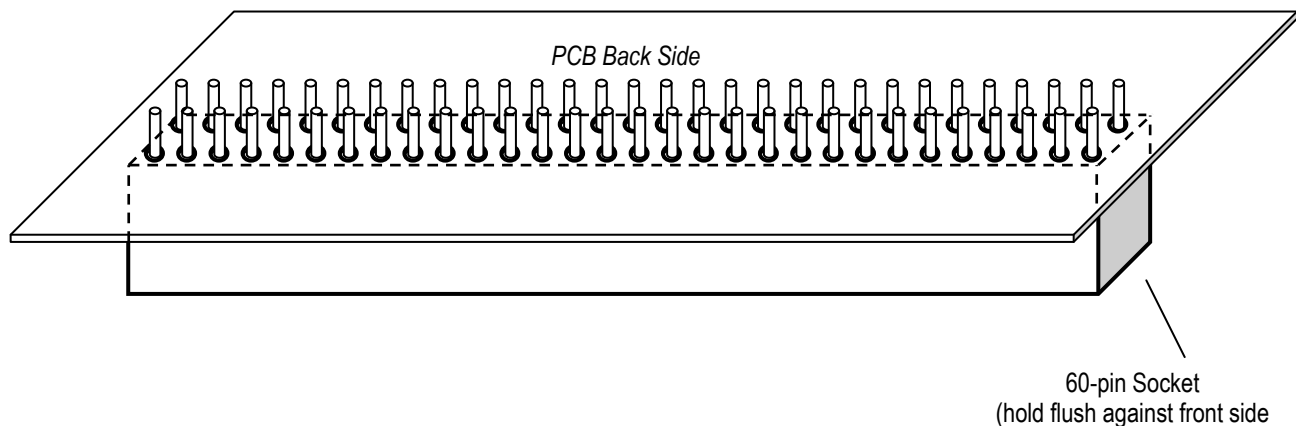

**Figure 1-4: Socket pins protruding from the back of the PCB**

*Hint: You may be able to hold the socket in place by resting the board face up flat on the bench top, with the socket sandwiched underneath. You might also choose to use some tape to hold the socket in place temporarily while you do the soldering.*



→ Carefully solder each of the 60 pins where they protrude from the back surface. Only use enough heat and solder to make a clean, shiny, and uniform joint that fills each pad but does not seep over to touch any of the adjacent pads. Have your instructor or TA look at your soldered socket and approve your technique before continuing.

## 1.5 Soldering Step 4: The Power System Components

In this section, the power system for the robot will be introduced. Hold the PCB with the front side up, the silk screen oriented so you can read the main labels, and locate the power section of the board in the lower left portion (see Figure 1-5).

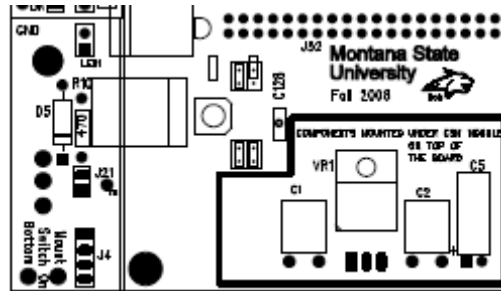

Figure 1-5: Power system section (front side, bottom left)

To begin with, be sure you understand the concept of polarized or directional components, meaning components that have a positive and negative direction: the diodes, the voltage regulator, and the electrolytic capacitor. This concept will be important in this sub-system.

If you have any questions do not hesitate to ask the instructor.

### 1.5.1 Components list

The components you will use for this step are listed below. The **bold** code refers to the component's name on the PCB silk screen. Find each of the power sub-system components from your parts kit:

- Two 0.1 $\mu$ F capacitors, **C1** and **C2** (non-polarized plastic film)
- One 120 $\mu$ F capacitor, **C5** (polarized aluminum electrolytic)
- One silicon power diode, **D5** (1N4004)
- One red or green LED, **LED1**
- One on/off switch, **S2**
- One 4-pin header, **J4**
- One 2-pin headers, **J21**
- Two 1-pin headers, **GND** and **+5V**

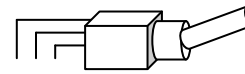
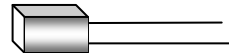
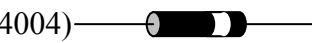
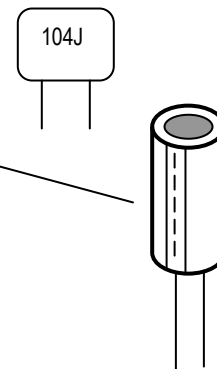

- One +5V regulator, **VR1** (LM7805)
- One shorting jumper 

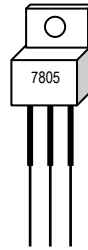

## 1.5.2 Installing the power sub-system headers

*Headers* are used with mating connectors and wires to reach other parts of the board, or with small *shorting jumpers* that slide on pairs of pins to make a connection. The silk screen shows headers with the abbreviation **J**.

First, pick out the required power system header sets: one group of 4 (**J4**), one group of 2 (**J21**), and two single-pin header (**J24 GND** and **J16 +5V**). Soldering the headers is a little trickier than the resistors and capacitors.

There are a few options for holding the header in position while you solder the pins.

- 1) If you are pretty comfortable with the soldering iron you can hold the header in place with a tweezers (or for multi-pin headers, your finger—but just touch one of the pins that is *not* being heated!) and solder the pin to the board. After securing the first pin of a multi-pin header, the section will hold itself in place so you can solder the rest of the pins.
- 2) Find something to support the header while you solder the back side pins. At this stage of assembly you can probably just use the bench top, but later other components may inhibit this method of soldering headers.
- 3) A piece of tape can be used to hold the header in place. In some ways this seems like the best option, but it is often hard to keep the header aligned perpendicularly to the board.

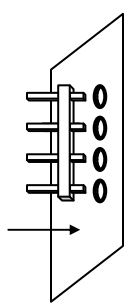

→ Place the 4-pin power system header (**J4**) into position by sliding the short ends of the jumper pins through the matching holes, decide how you will hold it in place, and then solder it from the back side.

→ Do the same for the 2-pin header **J21**.

→ The single pin **J24** attached to the board's ground potential (**GND**). **J24** is located over in the *middle left side* of the PCB just above the power section.

→ The single pin **J16 (+5V)** attached to the board's regulated power output potential is located in the middle of the power section.

As you will see later, there are a lot of headers to install on the board!

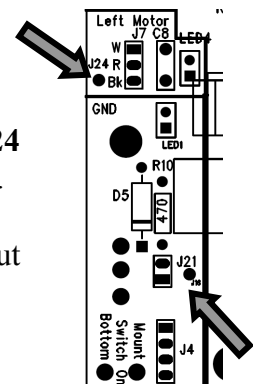



### 1.5.3 Power supply connector "key"

When the entire kit is assembled you will be powering your robot using a battery pack. The pack will connect to the PCB using the four header pins (**J4**) you just soldered in place. The positive (+) battery wire will connect to the top pin and the negative (-) battery wire will connect to the bottom pin. In order to make it less likely to connect the power backwards, we will *key* the connection by removing one of the header pins. The corresponding hole in the battery connector is plugged, so the connector can only be installed in the proper orientation.

→ Carefully clip off the *next-to-the-bottom* header pin of **J4**. The hole plug in the mating battery connector to make sure the positive and negative connections are correct.

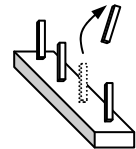

### 1.5.4 Installing the passive components

First identify the correct holes for the two 0.1 $\mu$ F (104) plastic film capacitors **C1** and **C2**.

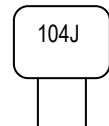

*Hint: The plastic film capacitors look a bit like Chiclets candy and do not have a polarization: they can go into the circuit in either orientation. However, be sure to choose the capacitor orientation so that the "104J" label will still be visible after installation.*

→ Insert the legs from the front side of the board so that you can see the capacitor's label and then *carefully* bend the capacitor backward to lie flush against the board. Now flip the board to the back side, and solder the capacitor legs in place on the back. Carefully clip off the excess wire.

Now place the 120 $\mu$ F aluminum electrolytic capacitor **C5** into its holes: make sure the negative lead and positive lead are oriented correctly.



*Hint: The electrolytic capacitor looks like a small metal can and is polarized: one of the leads is labeled "-", for negative, on the side of the capacitor. Make sure **the other** lead (positive) goes into the hole with the square pad near the "+" silk screen mark. Your board will not work if the electrolytic capacitor is inserted backwards!*

→ After double-checking the orientation, *carefully* bend the capacitor over to lie flush against the PCB, then solder the legs in place on the back. Carefully snip off the excess wire.

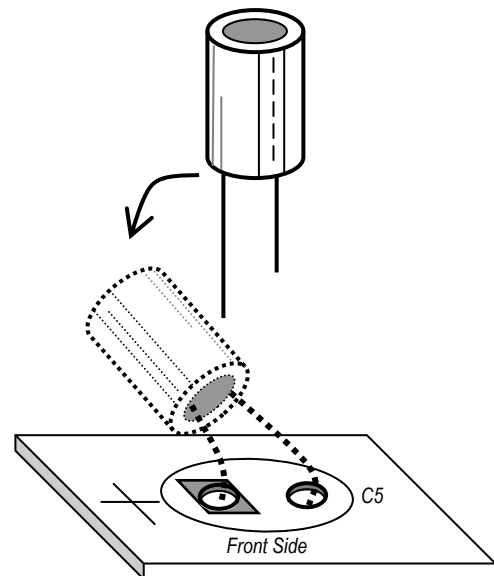

Next, locate the holes for the light-emitting diode (**LED1**) and the power diode (**D5**) in the lower left area of the board.



Hint: The LED (light emitting diode) is directional. The long wire is the anode and the short wire is the cathode. You may also be able to see the larger cathode element inside the LED package. Make sure the LED is inserted so the short wire (cathode end) goes through the square pad

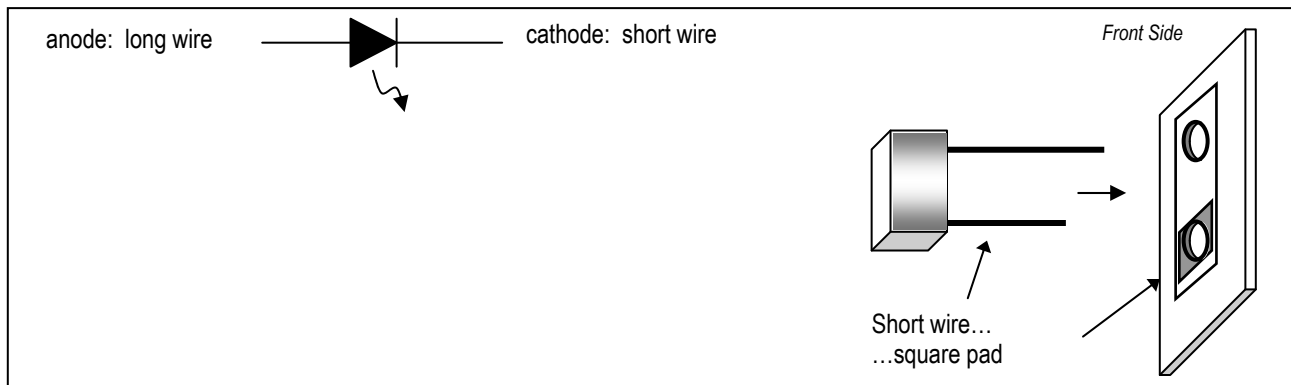

Hint: The proper direction for the power diode stripe corresponds to the white mark on the silk screen.

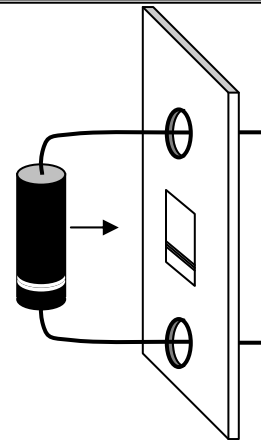

→ Solder the LED and the power diode into position. Both before and after soldering, verify the placement and orientation of each polarized component, and seek help if you notice any errors.

### 1.5.5 Installing the voltage regulator

The next piece that goes in the power sub-system is the 3-pin voltage regulator. The regulator takes the voltage from the batteries (which will vary with temperature, load, and as the batteries discharge), and electrically converts it to the constant +5 volts that is needed by the rest of the circuitry. The first pin is the *input* voltage, the second pin is the circuit *ground*, and the third pin is the *regulated 5 volts*.

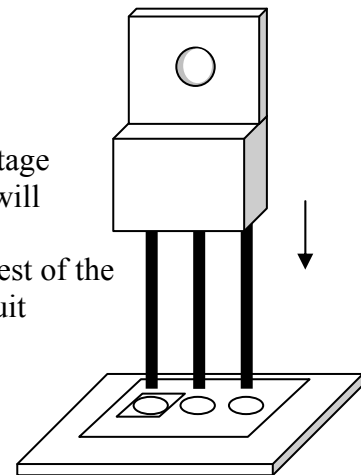

→ Insert the component from the front side of the PCB oriented so that the tab is toward the top and the label toward the bottom, *carefully* bend the regulator back flat against the PCB, and then solder the three pins on the back side. Gently clip off the excess wires after soldering.

### 1.5.6 Power switch

Finally, install the toggle switch on the *back* of the PCB. The switch has two “feet” that fit into the holes at the edge of the board, and three electrical contacts protruding from the rear. Hold the switch in place on the *back* of the board as you solder the five connections on the *front* of the board.

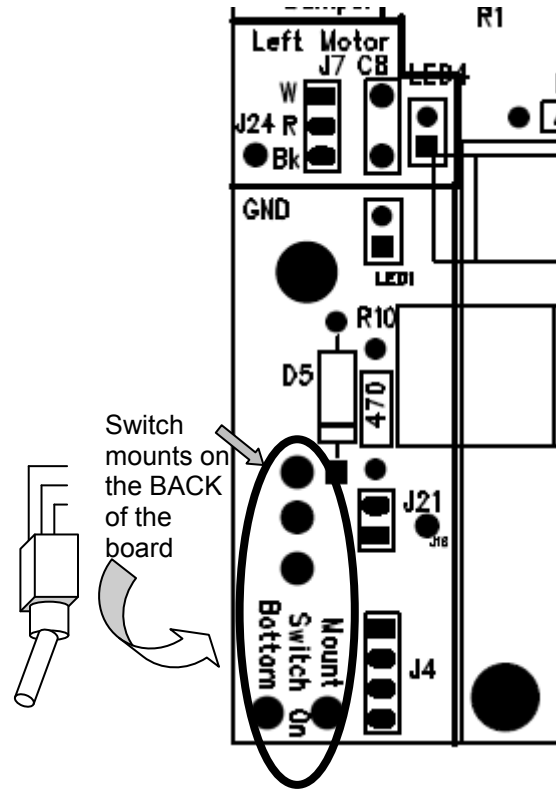

### 1.5.7 Visual inspection

Take a moment to examine your board carefully and critically.



- Were all the power system components installed?
- Are all the pins soldered completely?
- Are there any "whiskers" or "solder bridges" between the pads?
- Is there any loose debris (like solder crumbs or metal flakes) caught anywhere on the board? Look closely.
- Do you see any damage to the board or its components, like bent pins, cracked housings, or crushed LEDs?

Be sure to ask your instructor or lab TA to examine any questionable areas of your PCB.

## 1.5.8 Power sub-system testing

Once you get to the lab, find the test plugs shown here. These are *not* part of your lab kit: just use them temporarily in the lab room for testing purposes.

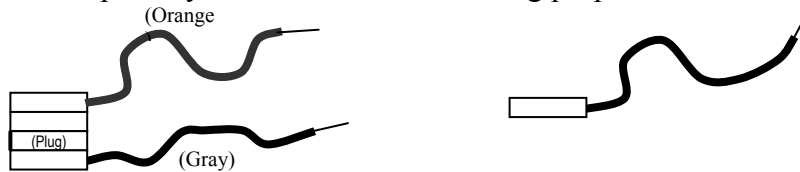

Attach a 4-socket pigtail to the power supply header (**J4**), and a single-socket pigtail to the *bottom* pin of 2-pin jumper **J21**.

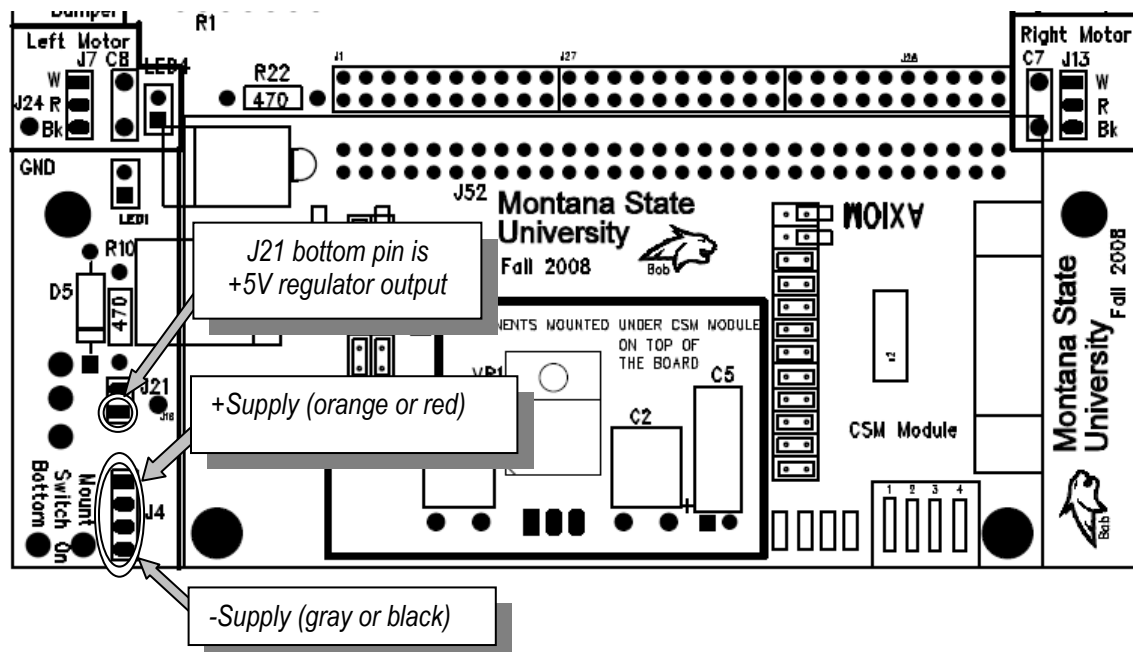

Figure 1-6: Power header detail (front side, bottom)

→ Set the DC bench power supply to 10 V using the DMM to verify the voltage. Connect the positive (red) wire from the supply to the orange or red wire of the pigtail using a banana cable and alligator clip. Connect the neutral (black) power supply wire to the gray or black pigtail using another banana cable and alligator clip.

→ Flip the toggle switch **S2** to the *up* position. This is the “on” position.

→ The voltage regulator output (5 volts) is sent to the bottom pin on header **J21** in the power supply area of the PCB. Use the DMM to measure the voltage between the bottom **J21** pin and the board ground test pin (**J24 GND**).



If you do NOT measure 5 volts, systematically check your connections and ask the instructor or TA for help.

If the measured regulator output voltage *is* 5 volts, proceed on to the next step.

→ Disconnect the DMM and single-socket pigtail from **J21**. Carefully slide a shorting jumper over the two **J21** header pins: this will connect 5 volts from the regulator to the  $V_{cc}$  supply bus on the board. This should illuminate **LED1**, located in the lower right of the board. If the LED does NOT light up, turn off the power supply and re-check all the connections. Seek help if you need it.

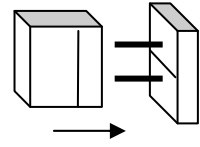

***This concludes soldering Part One.  
Your lab instructor will let you know when you should start work on assembly steps described  
in the Part Two instructions.***