



347 SOUTH FERGUSON, SUITE 3
BOZEMAN, MONTANA 59718
406.404.1588

PROJECT NO.: 20-0006

FIRE PROTECTION ENGINEER
MORRISON-MAIERLE
2880 TECHNOLOGY BLVD
BOZEMAN MT, 59718

MECHANICAL ENGINEER
MORRISON-MAIERLE
2880 TECHNOLOGY BLVD.
BOZEMAN MT, 59718

ELECTRICAL ENGINEER
MORRISON-MAIERLE
2880 TECHNOLOGY BLVD.
BOZEMAN MT, 59718

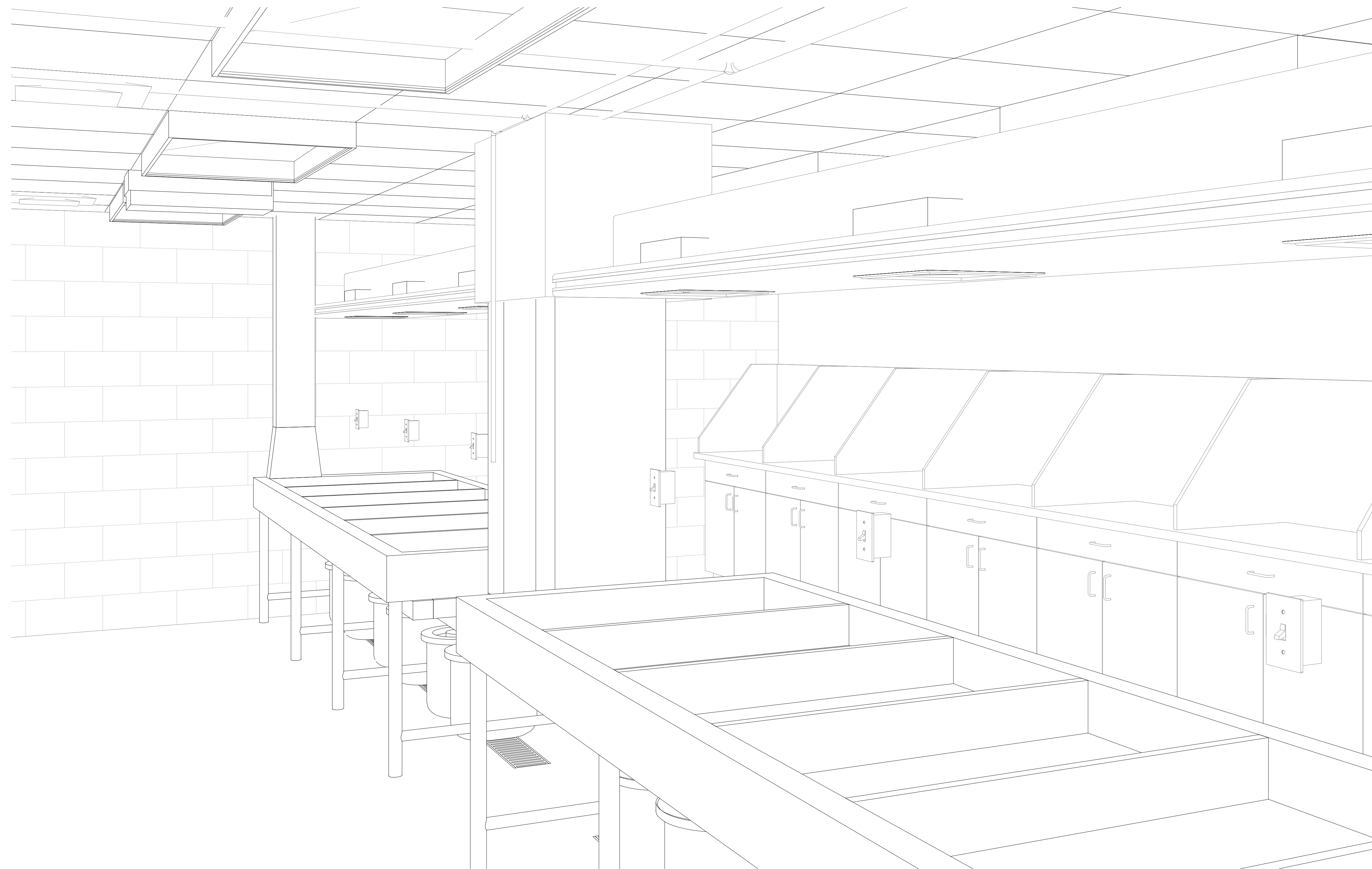

MONTANA STATE UNIVERSITY **VISUAL COMMUNICATIONS DARKROOMS 135 & 138 SINK REPLACEMENT**

AAI #23046.01

BID SET

ISSUE DATE: 04-25-2024

ARCHITECTURAL ABBREVIATIONS

& AND	F.E.C. FIRE EXTINGUISHER CABINET	FOI OWNER FURNISHED,
< ANGLE	FIN FINISH	OWNER INSTALLED
@ AT	FF FACTORY FINISH(ED)	OH OVERHEAD
CL CENTERLINE	FLUOR FLUORESCENT	OPNG OPENING
o DEGREE	F.O.B FACE OF BLOCK	OPP OPPOSITE
# NUMBER	F.O.F FACE OF FINISH	
	F.O.S FACE OF STUD	
ABV ABOVE	F.O FACE OF (Conc. etc.)	PARA PARALLEL
AC ASPHALTIC CONCRETE	F.R.P FIBER REINFORCED PANEL	PART PARTITION
ACP ACOUSTIC CEILING PANEL	FRFP FIRING	PERF PERFORATED
ACT ACOUSTICAL CEILING TILE	FRT FIRE-RETARDANT TREATED	PERM PERMANENT
ACOUS ACOUSTICAL	FT FOOT OR FEET	PERP PERPENDICULAR
ADD ADDITION	FTG FOOTING	P.I.C PRECAST INSULATED CONCRETE
AFF ABOVE FINISH FLOOR	FURR FURRING	PL PLATE
AHU AIR HANDLING UNIT	FUT FUTURE	P.LAM PLASTIC LAMINATE
ALT ALTERNATE		PLAST PLASTER
ALUM ALUMINUM	GA GAUGE	PLYWD PLYWOOD
APPROX APPROXIMATE	GAL GALLON	PR PAIR
ARCH ARCHITECTURAL	GALV GALVANIZED	PREFAB PREFABRICATED
ASPH ASPHALT	G.B. GRAB BAR	PRMA PROTECTED MEMBRANE ROOF
AVG AVERAGE	G.I. GALVANIZED IRON	ASSEMBLY
	GL GLASS	PROJECT
BD BOARD	GT GLASS TYPE	PT POINT AND PAINT
BLDG BUILDING	GTB GYPSUM WALL BOARD	P.T. PRESERVATIVE TREATED
BLKG BLOCKING	GYM GYMNASIUM	PTD PAPER TOWEL DISPENSER
BLW BELOW	GYP. GYPSUM	PVC POLYVINYL CHLORIDE
BM BENCH MARK		R RISER OR RADIUS
B.O. BOTTOM OF	H.B. HOSE BIB	R.D. ROOF DRAIN
B.S. BOTH SIDES	H.C. HOLLOW CORE	REF REFERENCE
BTU BRITISH THERMAL UNIT	HDWD HARDWOOD	REFR REFRIGERATOR
BUR BUILT-UP ROOF	H.M. HOLLOW METAL	REINF REINFORCING
	H.M.F HOLLOW METAL FRAME	REQ REQUIRED
CAB CABINET	H.P. HIGH POINT	R.H. RIGHT HAND
C.B. CATCH BASIN	HR HOUR	R.L. RAIN LEADER
CEM CEMENT	HT HEIGHT	RM ROOM
C.I. CAST IRON	HW HOT WATER	R.O. ROUGH OPENING
CIRC CIRCULAR	HWY HIGHWAY	R.O.W. RIGHT OF WAY
CLG CEILING		RTU ROOF TOP UNIT
CLR CLEAR		
C.M.P CORRUGATED METAL PIPE		S SOUTH
CMU CONCRETE MASONRY UNIT	I.D. INSIDE DIAMETER	SAN SANITARY
COL COLUMN	(") OR IN INCHES	S.C. SOLID CORE
COMP COMPOSITION	IHM INSULATED HOLLOW METAL	SCHED. SCHEDULE
CONC CONCRETE	INSUL INSULATION	SE SOUTH EAST
CONSTR CONSTRUCTION	INT INTERIOR	SECT SECTION
CONT CONTINUOUS	JAN JANITOR	SHEATH SHEATHING
COOR COORDINATE	JT JOINT	SHT SHEET
CORR CORRIDOR		SIM SIMILAR
C.R. COLD ROLLED	KIT KITCHEN	SANITARY NAPKIN DISPENSER
C.R.C COLD ROLLED CHANNEL		SPEC SPECIFICATIONS
C.T. CERAMIC TILE	LAB LABORATORY	SQ SQUARE
CTR CENTER	LAM LAMINATE OR LAMINATED	S.S. SANITARY SEWER
	LAV LAVATORY	S.ST STAINLESS STEEL
DBL DOUBLE	LB POUND	STOR STORAGE
DEPT. DEPARTMENT	LF LEFT HAND	STRUCT STRUCTURAL
D.F. DRINKING FOUNTAIN	LL LIVE LOAD	ST. S STORM SEWER
DET DETAIL	L.O.W LIMITS OF WORK	SUSP SUSPENDED
DIA DIAMETER	L.P LOW POINT	SV SHEET VINYL
DIAG. DIAGONAL		SW SOUTH WEST
DIM DIMENSIONAL	MAT'L MATERIAL	SYM SYMMETRICAL
DISP DISPENSER	MAX MAXIMUM	
DL DEAD LOAD	MECH MECHANICAL	TB TACKBOARD
DN. DOWN	MET OR MTL. METAL	TBHM THERMALLY-BROKEN HOLLOW METAL
DS DOWNSPOUT	MFR MANUFACTURER	TEL TELEPHONE
DWG DRAWINGS	MH MANHOLE	TEMP TEMPORARY
	MIN MINIMUM OR MINUTE	TERR TERRAZO
E EAST	MISC. MISCELLANEOUS	T&G TOUNGE AND GROOVE
EXISTING EXISTING	M.O MASONRY OPENING	T.O. TOP OF (eg. concrete)
EA EACH	MSU MONTANA STATE UNIVERSITY	T.O.S TOP OF STEEL
E.I.F.S EXTERIOR INSULATION & FINISH SYSTEM	MULL MULLION	TV TELEVISION
ELEV ELEVATION	N NORTH	TYP TYPICAL
ELEV ELEVATOR	NE NORTH EAST	
ELEC ELECTRICAL	NIC NOT IN CONTRACT	UL UNDERWRITERS LABORATORY
EMB EMBOSING	NO NUMBER	UNFIN UNFINISHED
EQ EQUAL	NOM NOMINAL	UNO UNLESS NOTED OTHERWISE
EQUIP EQUIPMENT	NTS NOT TO SCALE	VCT VINYL COMPOSITION TILE
E.G. EACH SIDE	NW NORTH WEST	VERT VERTICAL
EXIST. EXISTING	O OVER	VEST VESTIBULE
EXP EXPOSED	O.C. ON CENTER	VR VAPOR RETARDER
EXP AGG. EXPANSION EXPOSED	O.D. OUTSIDE DIAMETER	VTR VENT THROUGH ROOF
AGGREGATE	OFD OVERFLOW DRAIN	
EXP. JT. EXPANSION JOINT EXTERIOR	OFF OFFICE	W WEST
	OFCI OFFICER FURNISHED,	W/ WITH
F.B. FLAT BAR	CONTRACTOR INSTALLED	WC WATER CLOSET
F.D. FLOOR DRAIN		W/O WITH OUT
FDN FOUNDATION		WP WATER PROOF
F.E. FIRE EXTINGUISHER		WT WEIGHT

PROJECT DESCRIPTION

MONTANA STATE UNIVERSITY'S EXISTING VISUAL COMMUNICATIONS BUILDING IS RECEIVING UPGRADES TO THE EXISTING FILM DEVELOPING SINKS LOCATED IN ROOMS VCB 135 AND VSB 138. THE EXISTING FOUR SINKS, TWO (2) IN 135 AND TWO (2) IN 138, ARE BEING REPLACED WITH A NEW SINKS OF SIMILAR SIZE AND NEW VENTILATION SYSTEMS. THE NEW SINKS WILL INCLUDE INDIVIDUAL BASINS AND WILL BE PLUMBED TO PROVIDE FLEXIBILITY IN CAPTURING CHEMICALS THAT CANNOT BE DUMPED DOWN THE DRAINS. THE DARKROOM SINK WILL ALSO INCLUDE A SYSTEM FOR THE SAFE TRANSFERING OF CHEMICAL CANISTERS, WHICH ARE COLLECTED BY THE UNIVERSITY'S SAFETY RISK MANAGEMENT DEPARTMENT.

CONSTRUCTION WILL BE COMPLETED DURING THE SUMMER MONTHS WHEN THE DARKROOMS ARE UNOCCUPIED, CONTRACTOR TO COORDINATE WITH MONTANA STATE FOR ACCESS TO CONSTRUCTION AREAS.

DRAWING INDEX

GENERAL

G100 GENERAL NOTES, ABBREVIATIONS, MAP AND SHEET INDEX
A-LS10 OVERALL PLAN
A-LS11 LIFE SAFETY PLANS

ARCHITECTURAL

D101 DEMOLITION PLAN
A101 FLOOR PLAN
A201 REFLECTED CEILING PLAN
A301 INTERIOR ELEVATIONS
A401 DETAILS
A801 SPECIFICATIONS
A802 SPECIFICATIONS
A803 SPECIFICATIONS

MECHANICAL

M001 MECHANICAL LEGEND & NOTES
M002 MECHANICAL SPECIFICATIONS
M100 MECHANICAL PLAN
MD100 MECHANICAL DEMO PLAN

PLUMBING

P001 PLUMBING LEGEND & NOTES
P002 PLUMBING SPECIFICATIONS
P100 PLUMBING UNDERSLAB PLAN
P101 PLUMBING FLOOR PLAN
PD100 PLUMBING UNDERSLAB DEMO PLAN
PD101 PLUMBING DEMO PLAN

ELECTRICAL

E001 ELECTRICAL LEGENDS & NOTES
E002 ELECTRICAL SPECIFICATIONS
E100 ELECTRICAL DEMOLITION PLAN
E101 ELECTRICAL RENOVATION PLAN

STATE MAP

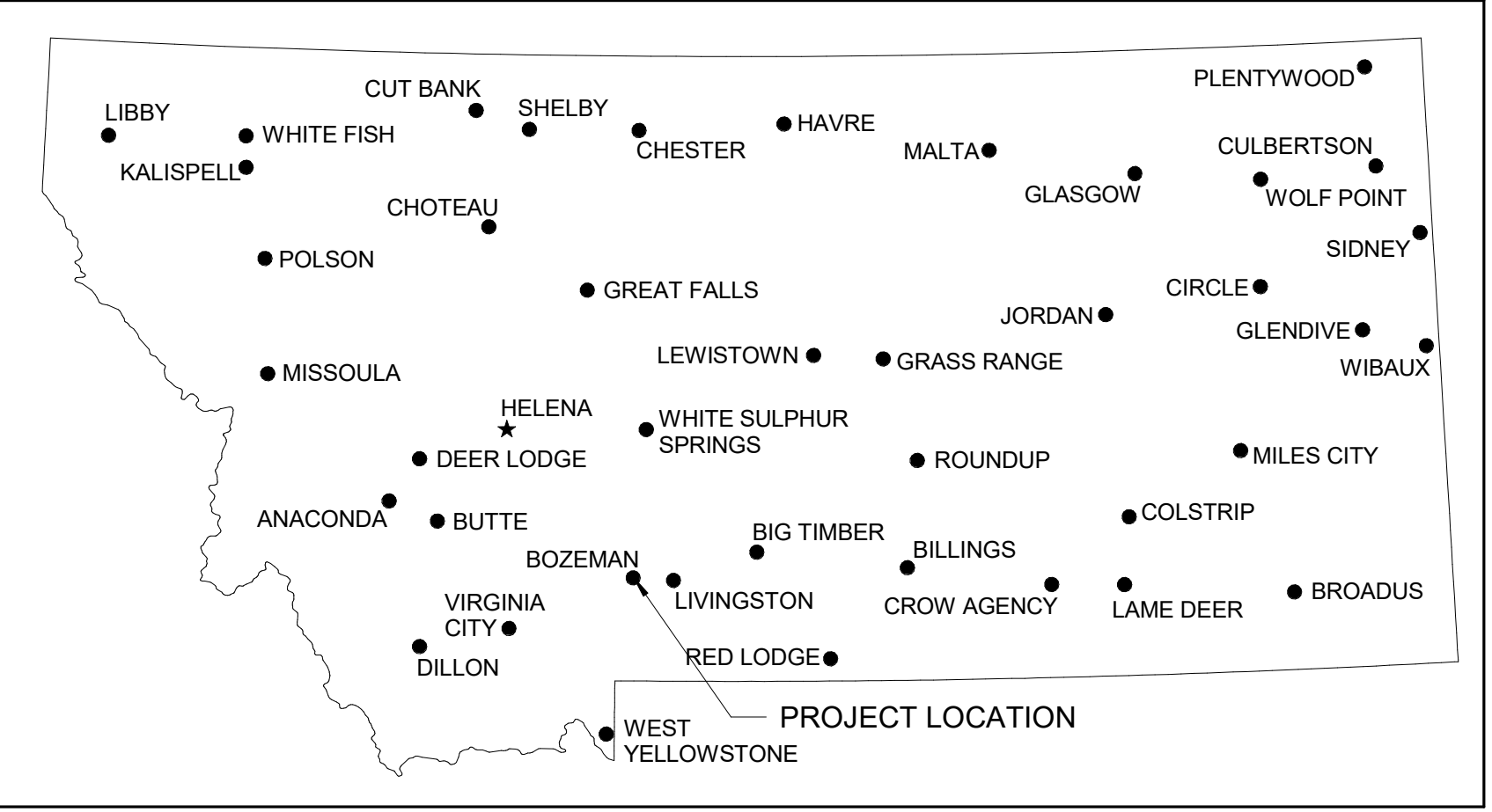

VICINITY MAP

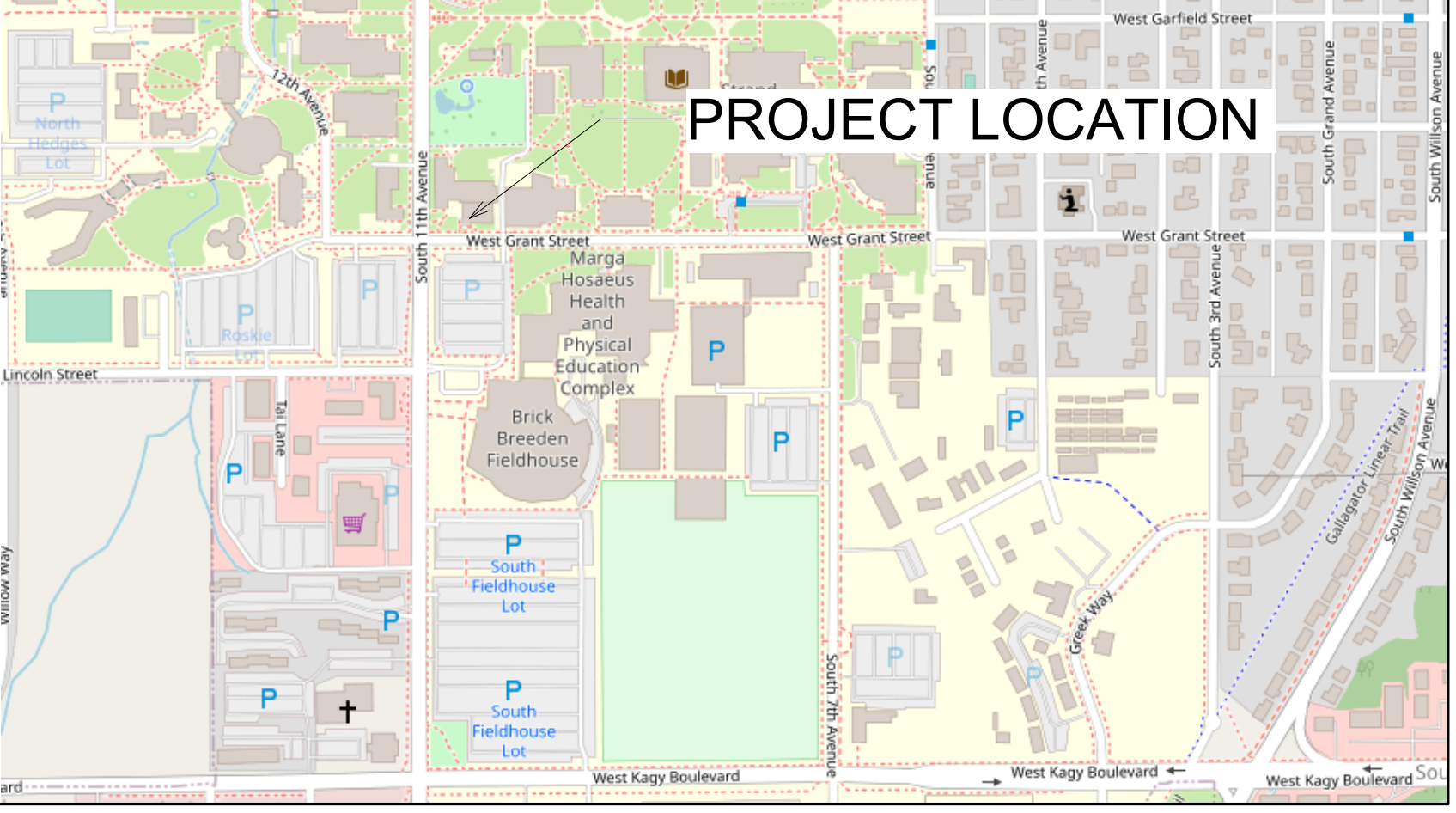

GENERAL PROJECT NOTES

- ALL WORK SHALL BE INSTALLED IN ACCORDANCE WITH THE PROVISIONS OF THE BUILDING CODES OUTLINED ON THE LIFE SAFETY PLAN, AND ALL OTHER STATE AND LOCAL CODES, INCLUDING ALL AMENDMENTS.
- ALL WORK SHALL CONFORM TO THE AMERICAN DISABILITIES ACT (A.D.A.) ACCESSIBILITY GUIDELINES FOR BUILDING AND FACILITIES (A.D.D.A.G.) AND A.N.S.I. 117.1 UNLESS NOTED OTHERWISE. WHERE CONFLICTING REQUIREMENTS OCCUR THE MOST UNLESS NOTED OTHERWISE.
- ALL DIMENSIONS ARE TO FACE OF STUD, FACE OF CONCRETE, FACE OF C.M.U., TO CENTERLINE OF STRUCTURAL COLUMN, OR TO STRUCTURAL GRID-LINE UNLESS NOTED OTHERWISE.
- DIMENSIONS NOTED AS "CLEAR" (OR CLR.) SHALL BE TO FINISHED FACE.
- DO NOT SCALE THE DRAWINGS TO OBTAIN CONSTRUCTION DIMENSIONS.
- EXCEPT AS SPECIFICALLY PERMITTED BY THE APPLICABLE BUILDING CODE, EGRESS DOORS SHALL BE READILY OPENABLE FROM THE EGRESS SIDE WITHOUT THE USE OF A KEY OR SPECIAL KNOWLEDGE EFFORT.

ARCHITECTURAL DRAWING CONVENTIONS

NORTH ARROW	GRID LINES	SHEET NOTE TAG	BLDG./WALL SECT.	DISCIPLINE	DETAIL	EXTERIOR ELEVATION	PARTITION TYPE	EQUIPMENT TAG
REVISIONS	DOOR NUMBER	DEMOLITION	VERT. CONTROL POINT	WINDOW TYPE	ROOM TAG	INTERIOR ELEVATION	MATCHLINE	



MSU-CPDC
MONTANA STATE UNIVERSITY
BOZEMAN, MONTANA
PHONE: 406.994.5413
FAX: 406.994.5665

**VISUAL COMMUNICATIONS
DARKROOMS 135 & 138 SINK
REPLACEMENT**
MONTANA STATE UNIVERSITY



DRAWN BY: TB
REVIEWED BY: MM
REV. DESCRIPTION DATE
1

PPA#20-0006
A/E#23061.01
Consultant #:
SHEET TITLE
GENERAL NOTES,
ABBREVIATIONS,
MAP AND SHEET
INDEX
G100
DATE
04-25-2024

DRAWN BY: TB		
REVIEWED BY: MM		
REV.	DESCRIPTION	DATE

PPA#20-0006
A/E#23061.01
Consultant #:

SHEET TITLE
OVERALL PLAN

SHEET
A-LS10

DATE
04-25-2024

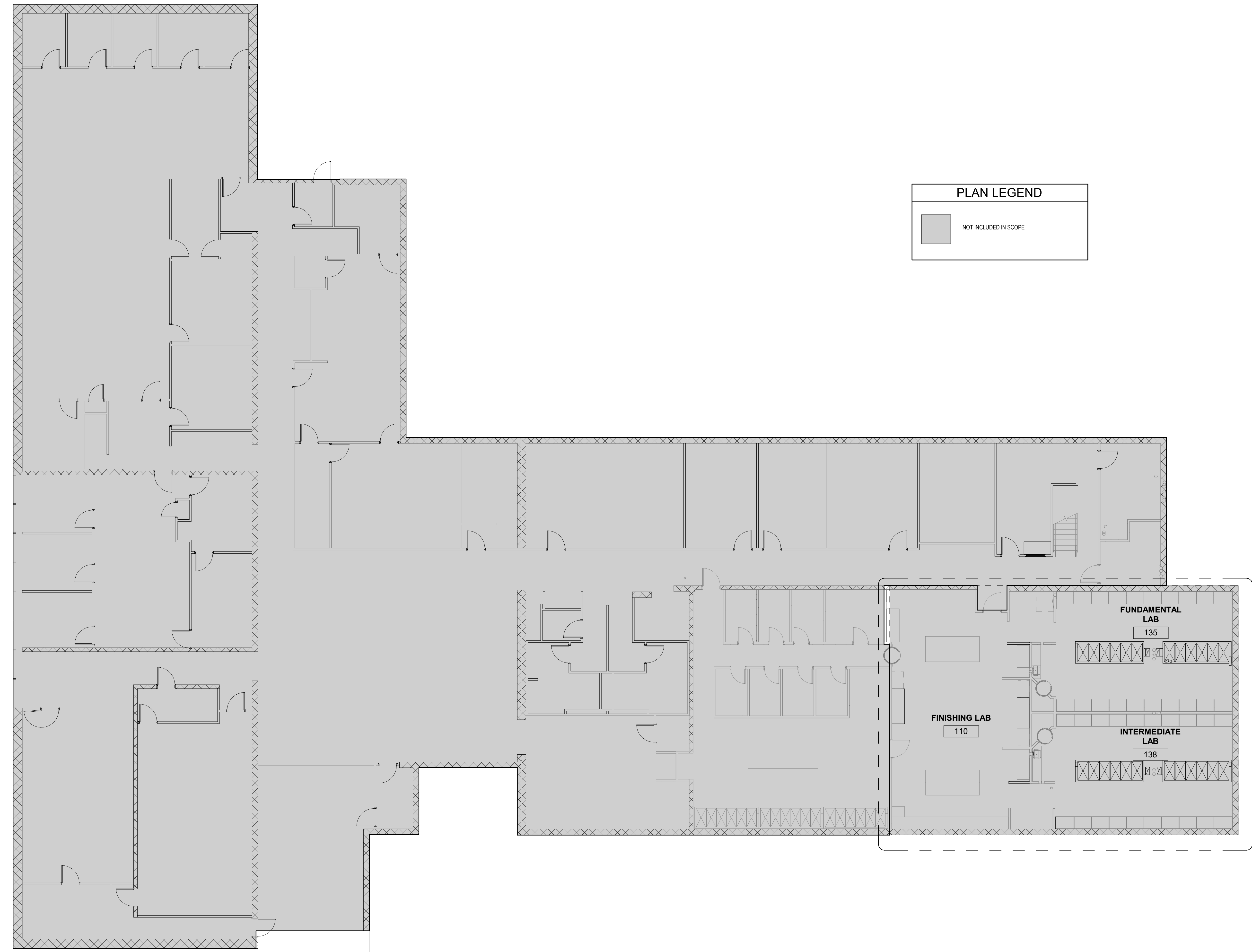

PLAN LEGEND

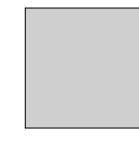
 NOT INCLUDED IN SCOPE

1 OVERALL PLAN
1/8" = 1'-0"



BUILDING CODE INFORMATION

LEVEL 1 ALTERNATION PER IEBC 2021
 LEVEL 1 ALTERATIONS INCLUDE THE REMOVAL AND REPLACEMENT OR THE COVERING OF EXISTING MATERIALS, ELEMENTS, EQUIPMENT OR FIXTURES USING NEW MATERIALS, ELEMENTS, EQUIPMENT, OR FIXTURES THAT SERVE THE SAME PURPOSE.

EXISTING BUILDING CONSTRUCTION TYPE IIB

AREA OF WORK IS 39,245 SF WITHIN 2,268 SF VISUAL COMMUNICATIONS BUILDING.

OCCUPANCY OF SPACES PER IBC 2021, TABLE 1004.5
 EDUCATIONAL - VOCATIONAL AREAS - 50 NET

EXISTING EXITING LOADING ON NORTH COORIDOR:
 EXISTING LABS 110, 135, 138 = 36 OCCUPANTS

TABLES 1006.2.1 SPACES WITH ONE EXIT - E, A, AND B OCCUPANCY = 49 OCCUPANTS

COMMON PATH OF EGRESS: E OCCUPANCY = 75 FT
 1017.2 EXIT ACCESS TRAVEL DISTANCE FOR E OCCUPANCY WITHOUT SPRINKLER SYSTEM = 200 FT

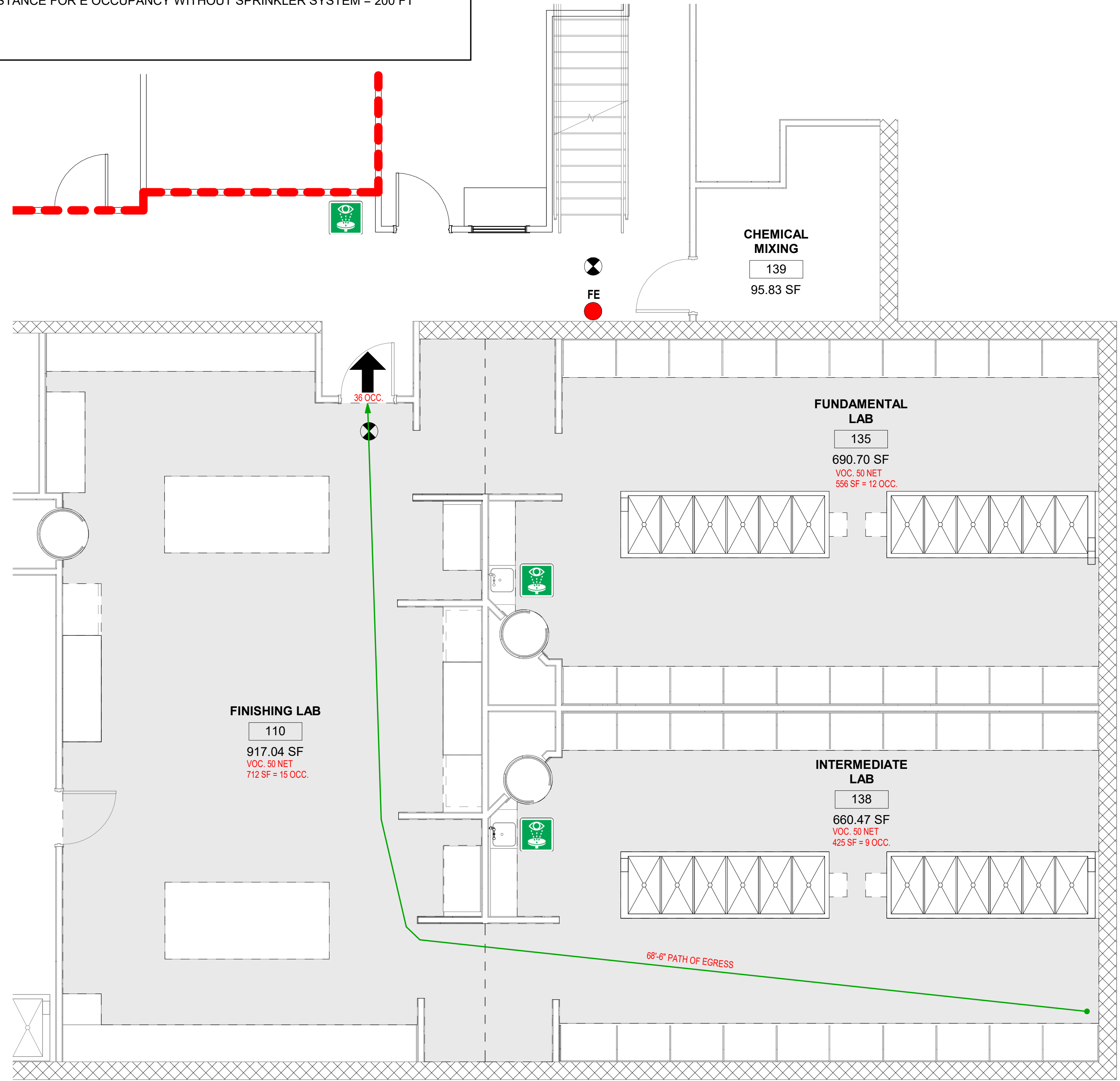
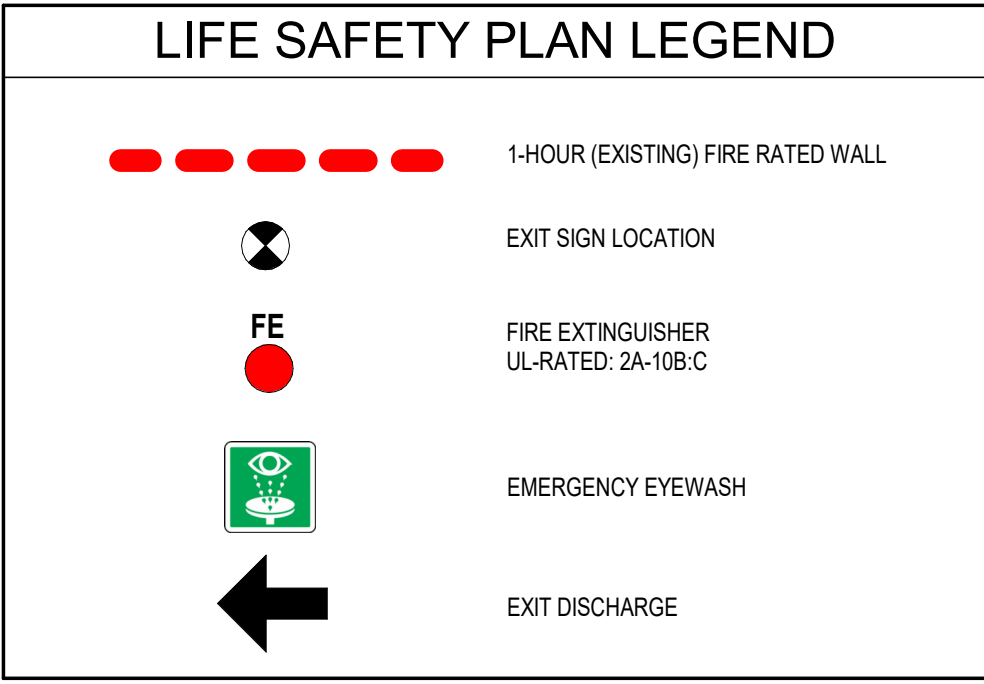

1 LIFE SAFETY PLAN
1/4" = 1'-0"

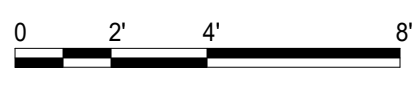

MSU-CPDC
 MONTANA STATE UNIVERSITY
 BOZEMAN, MONTANA
 PHONE: 406.994.5413
 FAX: 406.994.5665

BID SET

**VISUAL COMMUNICATIONS
 DARKROOMS 135 & 138 SINK
 REPLACEMENT**

MONTANA STATE UNIVERSITY



DRAWN BY:	TB	
REVIEWED BY:	MM	
REV.	DESCRIPTION	DATE

PPA#20-0006
 A/E#23061.01
 Consultant #:

SHEET TITLE
 LIFE SAFETY
 PLANS

SHEET
A-LS11

DATE
 04-25-2024

DRAWN BY:	TB
REVIEWED BY:	MM
REV.	DESCRIPTION DATE

PPA#20-0006
 A/E#23061.01
 Consultant #:

SHEET TITLE
 DEMOLITION PLAN

SHEET
D101

DATE
 04-25-2024

GENERAL DEMOLITION NOTES

1. REMOVE EXISTING PHOTO DEVELOPING SINKS
 2. OVERHEAD SHELVING, VENTILATION DUCT AND LIGHTING CASEMENT TO REMAIN

NOTE: FOR LIGHTING DEMOLITION SEE SHEET ED101.

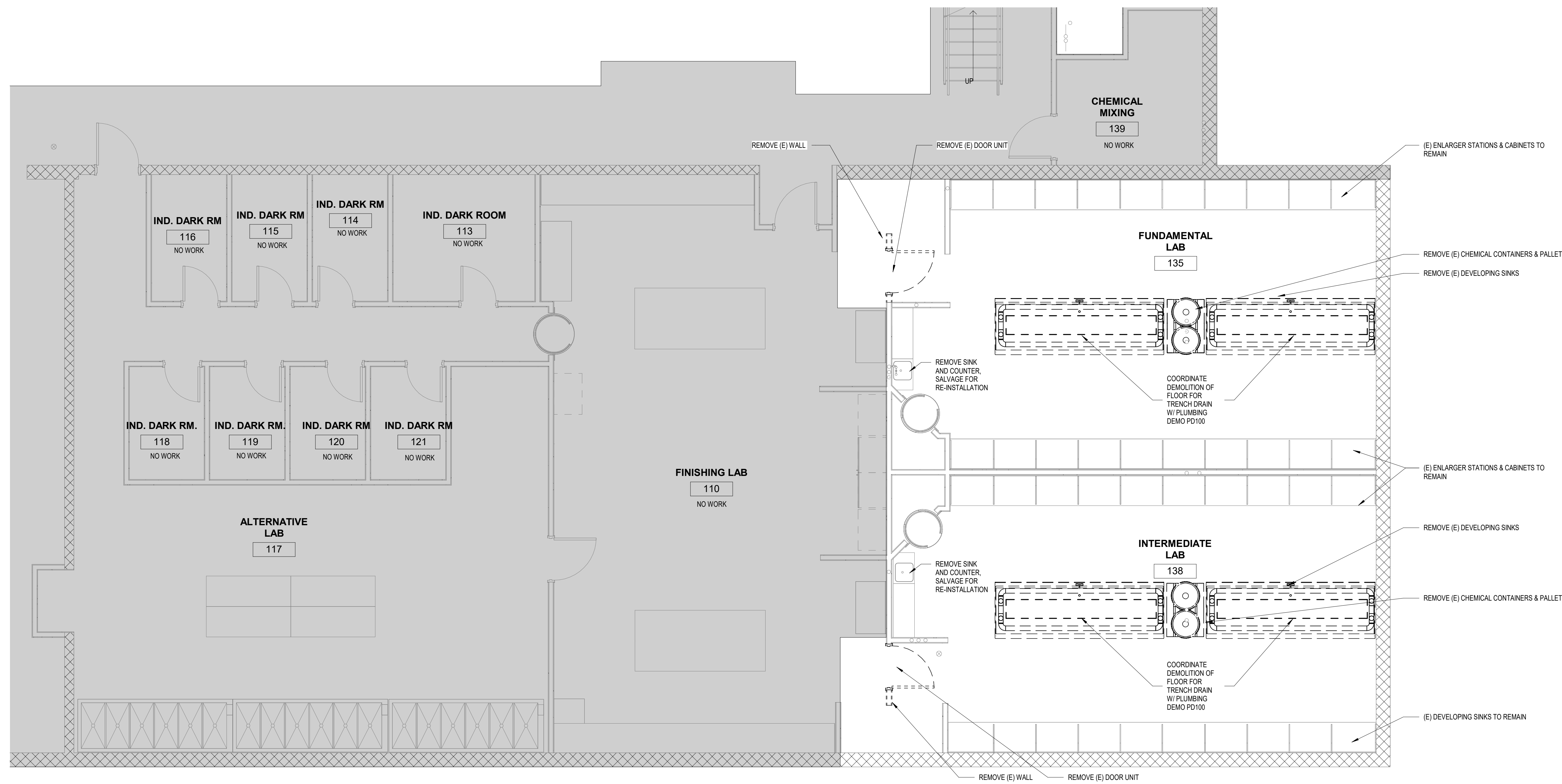

1 DEMOLITION PLAN
 1/4" = 1'-0"



BID SET

DRAWN BY:	TB	
REVIEWED BY:	MM	
REV.	DESCRIPTION	DATE

PPA#20-0006
 A/E#23061.01
 Consultant #:

SHEET TITLE
 FLOOR PLAN

SHEET
A101

DATE
04-25-2024

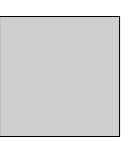
PLAN LEGEND	
	NOT INCLUDED IN SCOPE

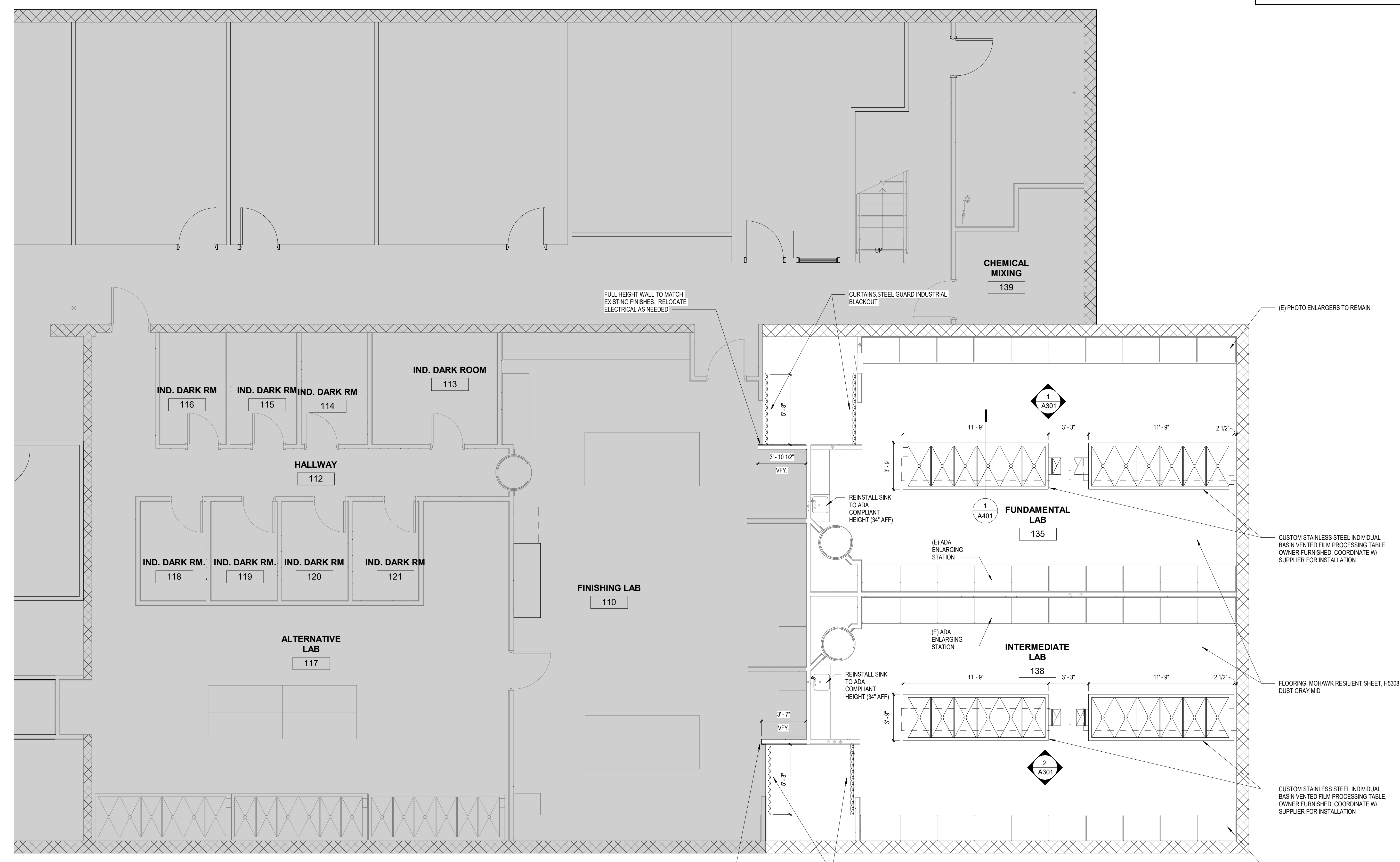

1 MAIN LEVEL FLOOR PLAN
 A101 1/4" = 1'-0"

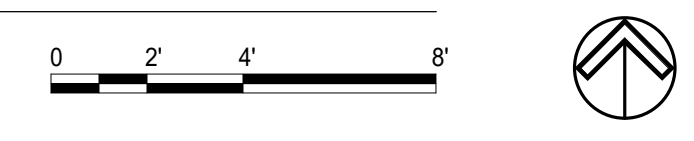

DRAWN BY:	TB	
REVIEWED BY:	MM	
REV.	DESCRIPTION	DATE

PPA#20-0006
 A/E#23061.01
 Consultant #:

SHEET TITLE
 REFLECTED
 CEILING PLAN







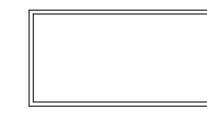

SHEET
A201

DATE
04-25-2024

PLAN LEGEND

	NOT INCLUDED IN SCOPE
---	-----------------------

REFLECTED CEILING PLAN LEGEND

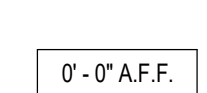
	2x2 SUSPENDED ACOUSTICAL CEILING
	RECESSED 2x4 LIGHT FIXTURE, SEE ELECTRICAL
	CEILING HUNG SAFE LIGHT, SEE ELECTRICAL
	SAFE LIGHT OVER SINK SHELVEING, SEE ELECTRICAL
	CURTAIN TRACK
	24"x24" SUPPLY AIR, SEE MECHANICAL
	24"x24" RETURN AIR, SEE MECHANICAL
	DUCT, SEE MECHANICAL
	EXHAUST FAN, SEE MECHANICAL
	0'-0" A.F.F. CEILING HEIGHT AS INDICATED

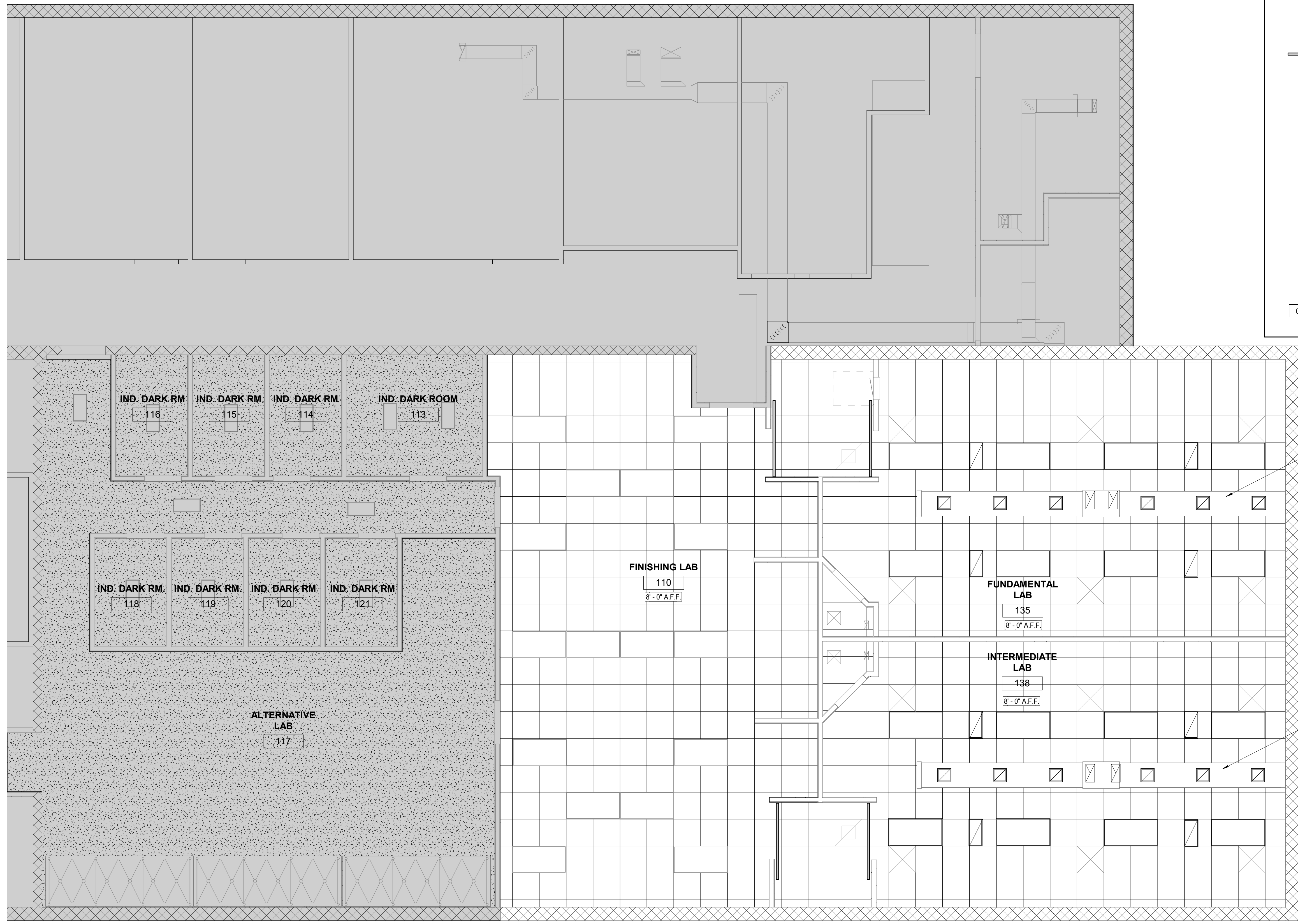

(E) SAFE LIGHT CASEMENT & OVER SINK SHELVEING

(E) SAFE LIGHT CASEMENT & OVER SINK SHELVEING

NOTE: REPLACE DAMAGED CEILING TILES AS NEEDED. MATCH EXISTING. ANTICIPATE 5% REPLACEMENT

1 REFLECTED CEILING PLAN
 1/4" = 1'-0"

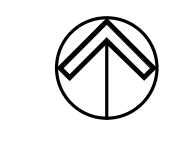
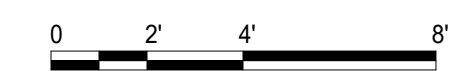

DRAWN BY:	TB	
REVIEWED BY:	MM	
REV.	DESCRIPTION	DATE

PPA#20-0006
 A/E#23061.01
 Consultant #:

SHEET TITLE
 INTERIOR
 ELEVATIONS

SHEET
A301

DATE
 04-25-2024

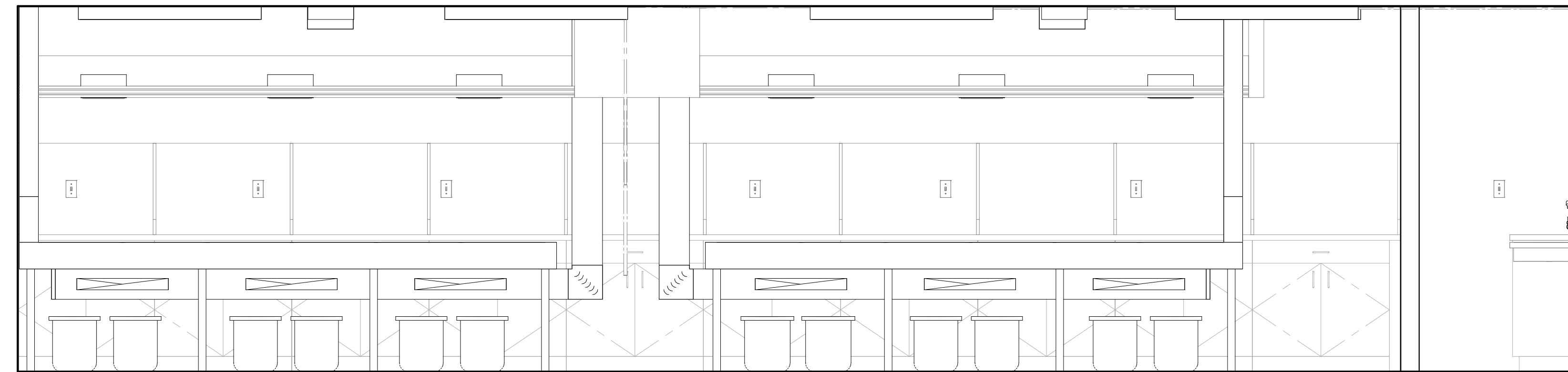

SOUTH

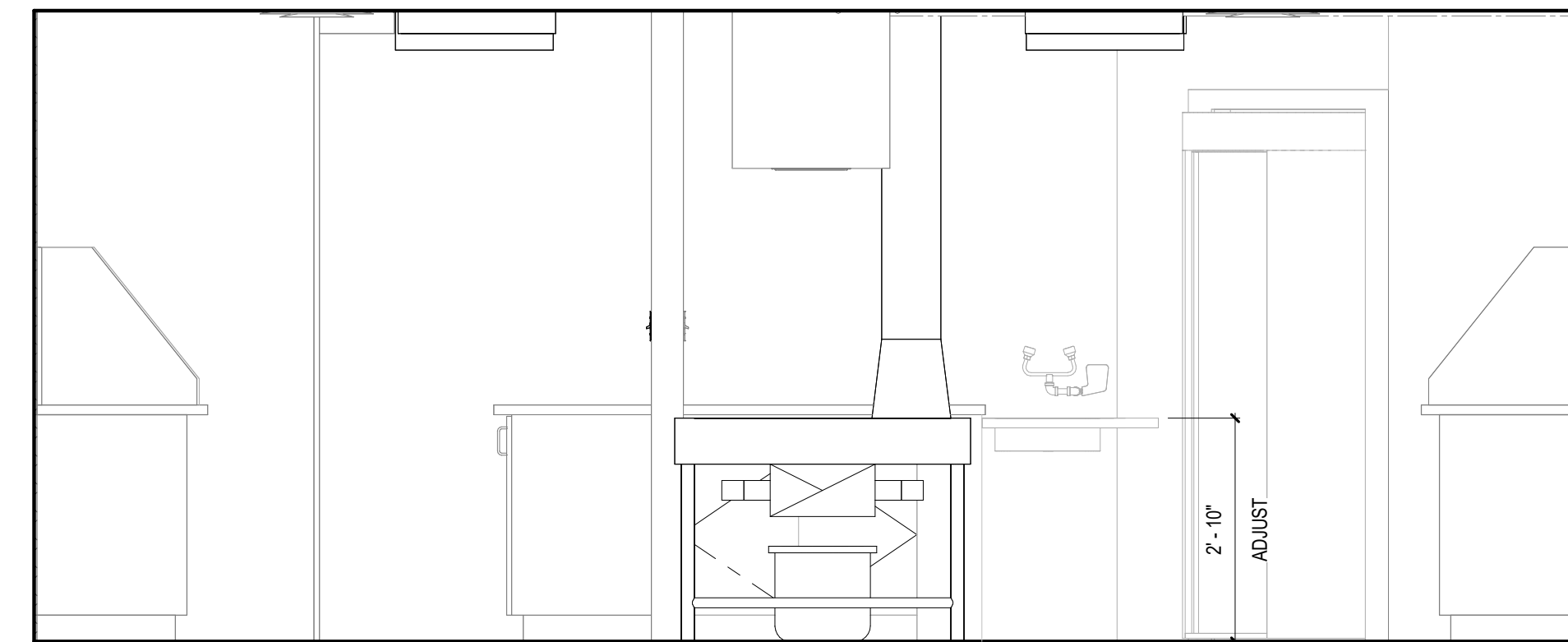

WEST

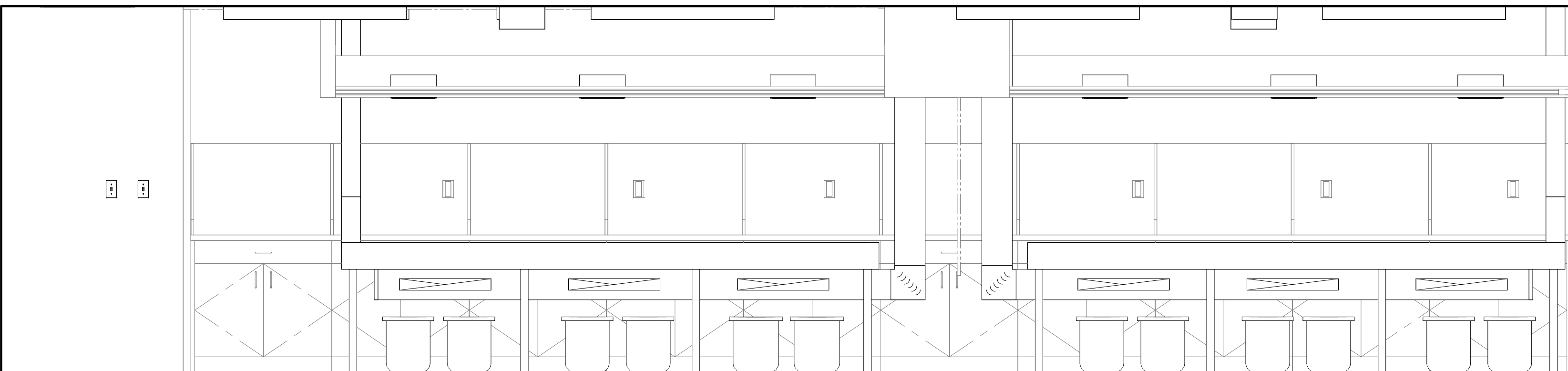

NORTH

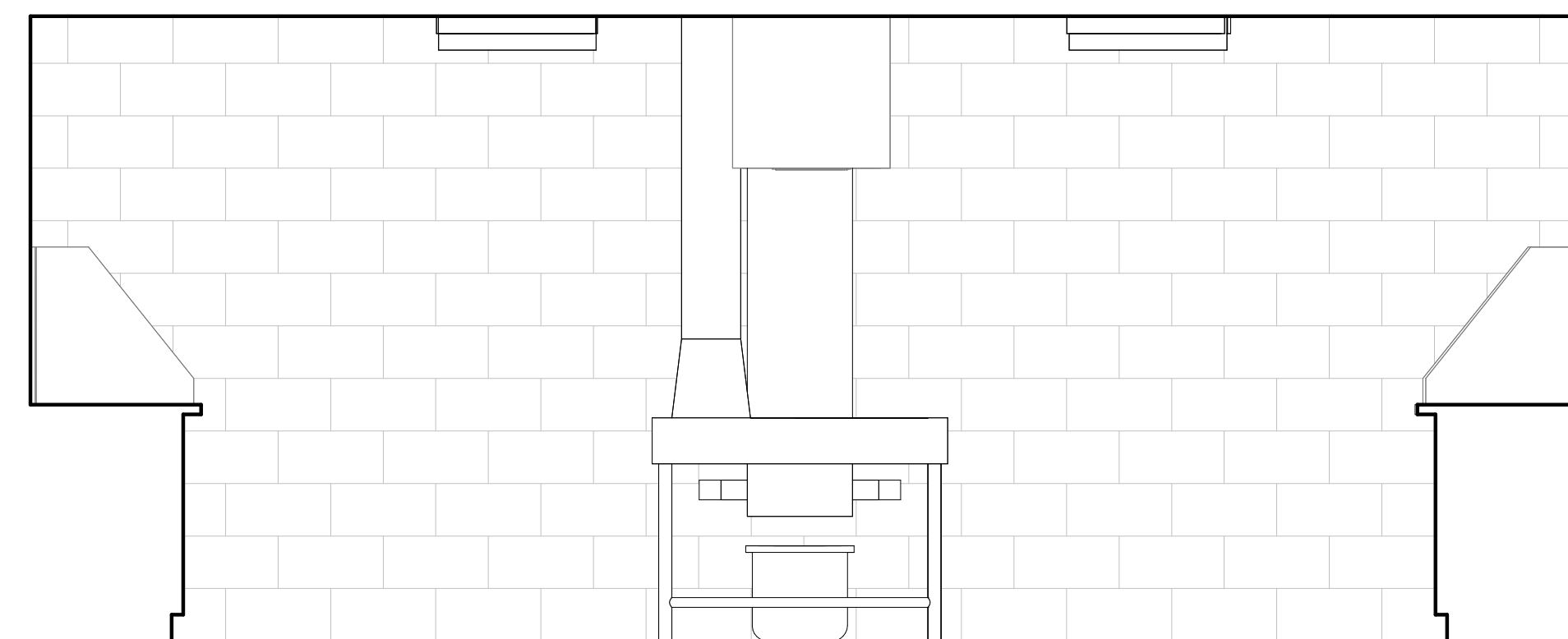

EAST

2 INTERMEDIATE LAB
 1/2" = 1'-0"

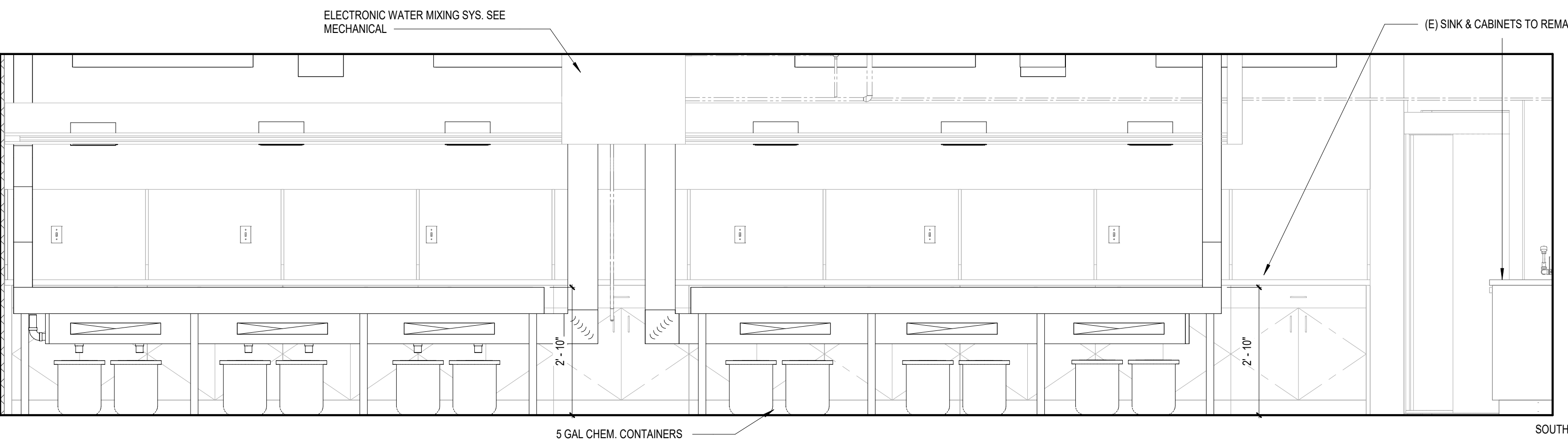

SOUTH

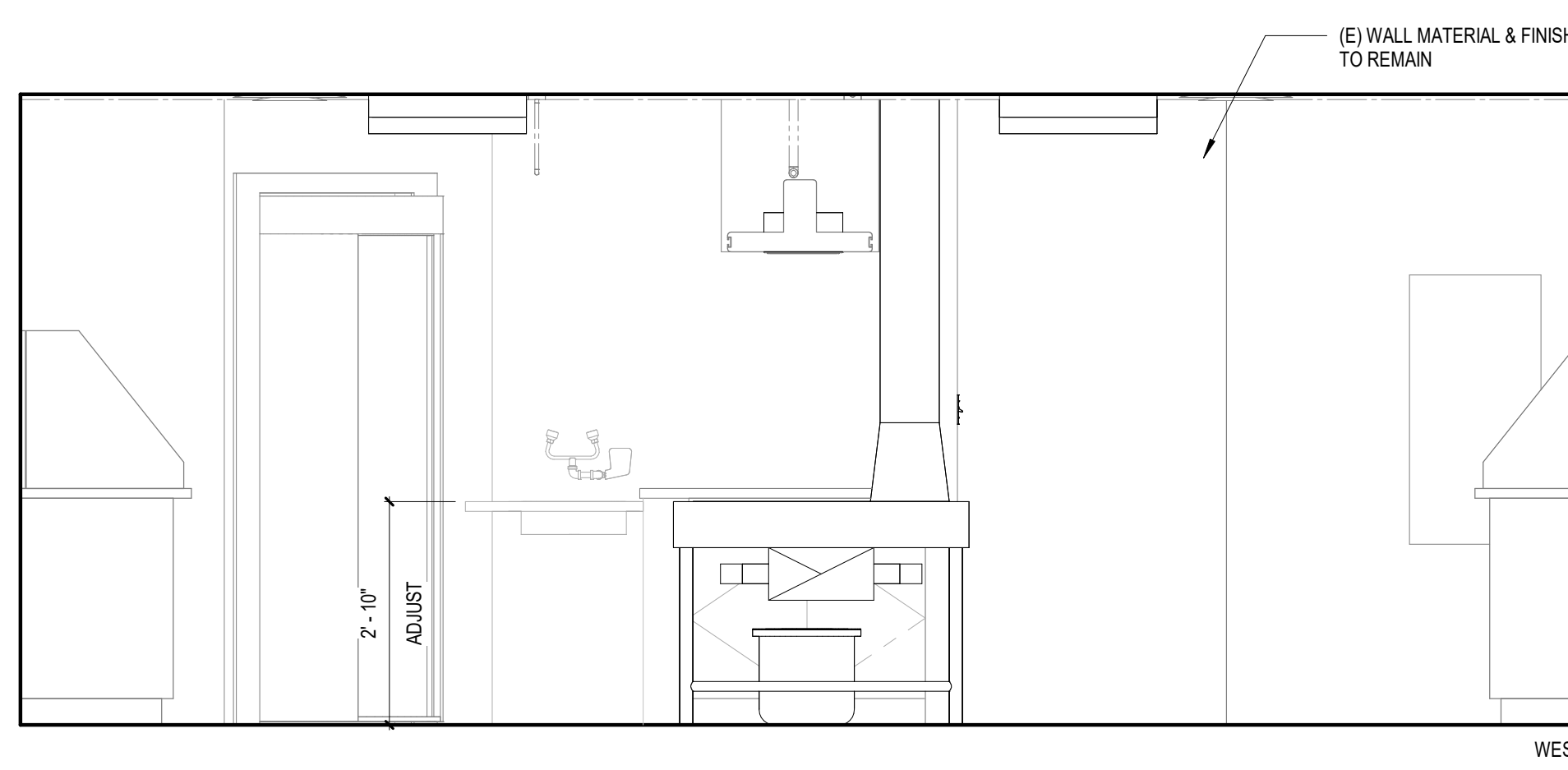

WEST

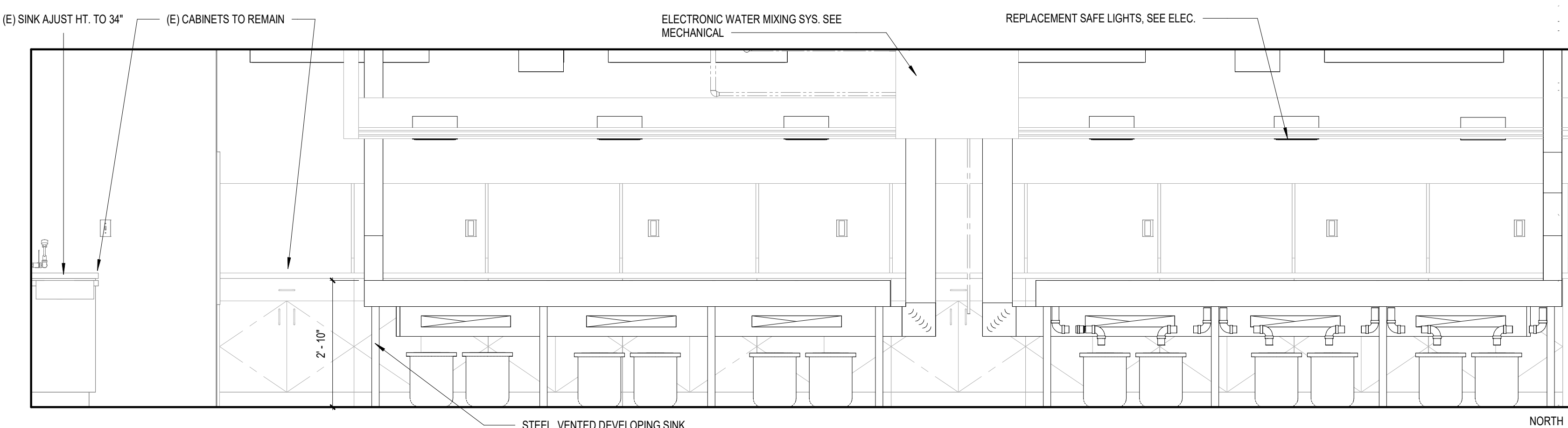

NORTH

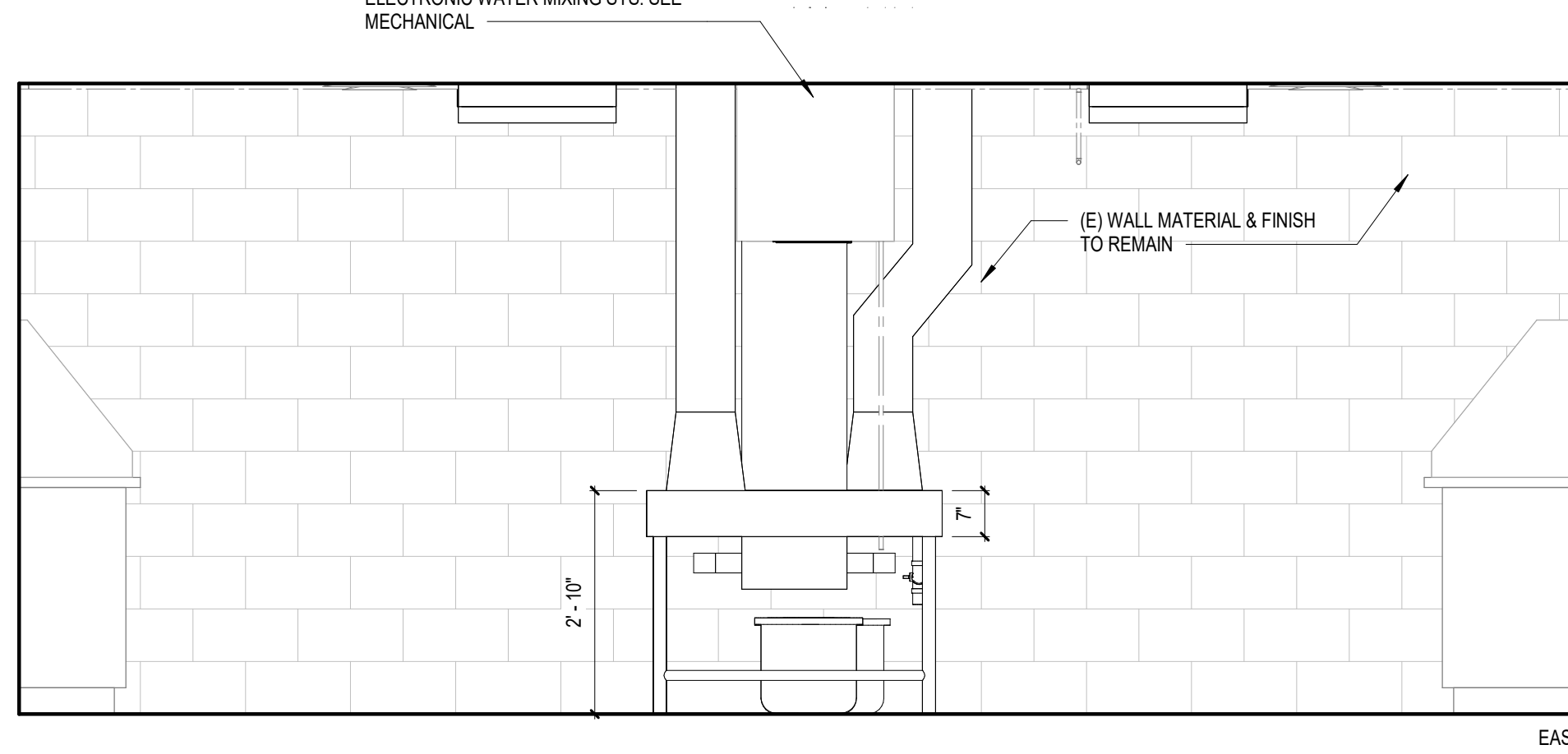

EAST

1 FUNDEMENTAL LAB
 1/2" = 1'-0"

"BASIS OF DESIGN"

Qty	Description
4	DI42125SHRV Photographic Specific Type 316, 16 GA. Stainless Steel Print Processing Sink Box Channel - Square outside Corner ALL Covered Inside Corners, Stainless Steel RIM Slot Ventilation Six (6) SECTION PAN Approx. Dimensions: 22.5" x 42" Inside Dimensions S/S Drain Fittings w/ Manual Mechanical Stopper Valve. Below Sink Exhaust Collar Connections Stainless Steel Square Tube Removable Base



PHOTOGRAPHIC DARKROOMS
Designers Suppliers Installers
193 Rocky Point Landing Rd.
Rocky Point, NY 11778
Phone: 631/821-5948
Fax: 631/821-8743
www.darkroomsinc.com

**PRINT PROCESSING ASSEMBLY, RIM VENTILATION
SEPARATE INTEGRAL COMPARTMENTS**
Location: Room A Quantity Required: 1
Item: Walk Around Sink Model No. DI42125SHRV

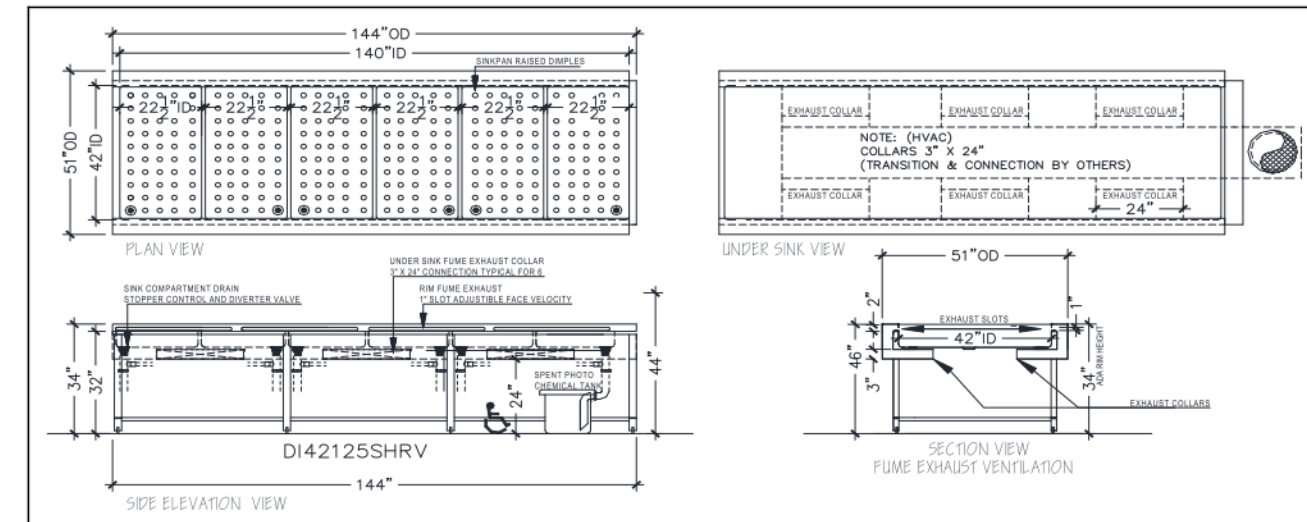

Construction Features:

- All Type 316 stainless steel passivated; all exposed surfaces are polished to a #4 finish.
- Sink rims are 1 1/2" box channel formed, Square outside Corners; Welding is inert heliarc method;
- Sink pan is ALL 1/2" covered inside cornered, and insulated via mastic underlayment to minimize condensation and temperature loss.
- Stand Base is constructed of Stainless Steel 1 1/2" Square Tubing. The stand base has stainless steel leveling adjustment designed to be removable for ease of shipping and access.

Space and Service Requirements:

- Overall Area: 51" Wide x 144" Long
- Height: ADA Sink Rim 34" AFF.
- Processing Utilization Area: **42"W x 137 1/2"L X 5" I.D. DIVIDED INTO SIX(6) COMPARTMENTS**
- Individual Sink Compartment Area: **42"W x 22 1/2"L X 5" I.D.**
- Drains: 1-1/2" IPS Individual Stopper Control and Diverter Valves
- Exhaust: Total **AVAILABLE - 650CFM**; Divided to Four(4) Collars, 3" x 24" @ 24" AFF. Approx. Under Sink
Mechanical Engineer to calculate, size and confirm all Exhaust Requirements.

Basic Sink Components:

- Sink pan, Dual Depth Sink Compartments #16 GA. Type 316 Stainless Steel
- Stand Base Stainless Steel
- Drain Fittings (1 1/2") Type 316 Stainless Steel
- Rim Ventilation and Transition Collars Type 316 Stainless Steel

Plumbing Package:

- (6) DDV-6 Spent Chemical Drain Outlet, Stopper and Diverter Valve

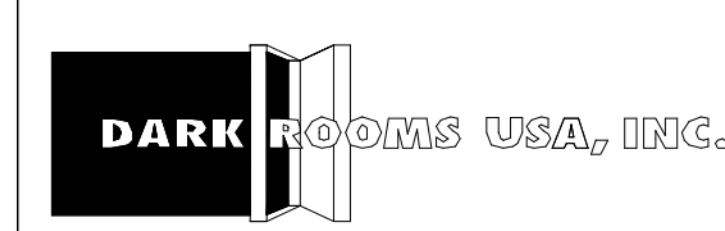

PHOTOGRAPHIC DARKROOMS
Designers Suppliers Installers
193 Rocky Point Landing Rd.
Rocky Point, NY 11778
Phone: 631/821-5948
Fax: 631/821-8743
www.darkroomsinc.com

**PRINT PROCESSING ASSEMBLY, RIM VENTILATION
SEPARATE INTEGRAL COMPARTMENTS**
Location: Room B Quantity Required: 1
Item: Walk Around Sink Model No. DI42125SHRV

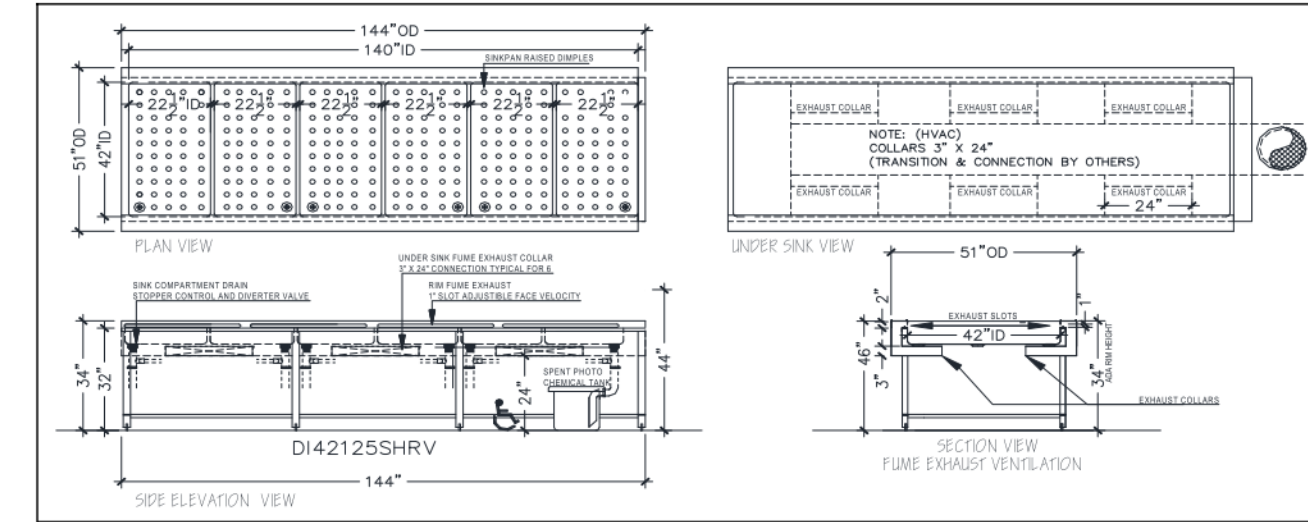

Construction Features:

- All Type 316 stainless steel passivated; all exposed surfaces are polished to a #4 finish.
- Sink rims are 1 1/2" box channel formed, Square outside Corners; Welding is inert heliarc method;
- Sink pan is ALL 1/2" covered inside cornered, and insulated via mastic underlayment to minimize condensation and temperature loss.
- Stand Base is constructed of Stainless Steel 1 1/2" Square Tubing. The stand base has stainless steel leveling adjustment designed to be removable for ease of shipping and access.

Space and Service Requirements:

- Overall Area: 51" Wide x 144" Long
- Height: ADA Sink Rim 34" AFF.
- Processing Utilization Area: **42"W x 137 1/2"L X 5" I.D. DIVIDED INTO SIX(6) COMPARTMENTS**
- Individual Sink Compartment Area: **42"W x 22 1/2"L X 5" I.D.**
- Drains: 1-1/2" IPS Individual Stopper Control and Diverter Valves
- Exhaust: Total **AVAILABLE - 650CFM**; Divided to Four(4) Collars, 3" x 24" @ 24" AFF. Approx. Under Sink
Mechanical Engineer to calculate, size and confirm all Exhaust Requirements.

Basic Sink Components:

- Sink pan, Dual Depth Sink Compartments #16 GA. Type 316 Stainless Steel
- Stand Base Stainless Steel
- Drain Fittings (1 1/2") Type 316 Stainless Steel
- Rim Ventilation and Transition Collars Type 316 Stainless Steel

Plumbing Package:

- (6) DDV-6 Spent Chemical Drain Outlet, Stopper and Diverter Valve

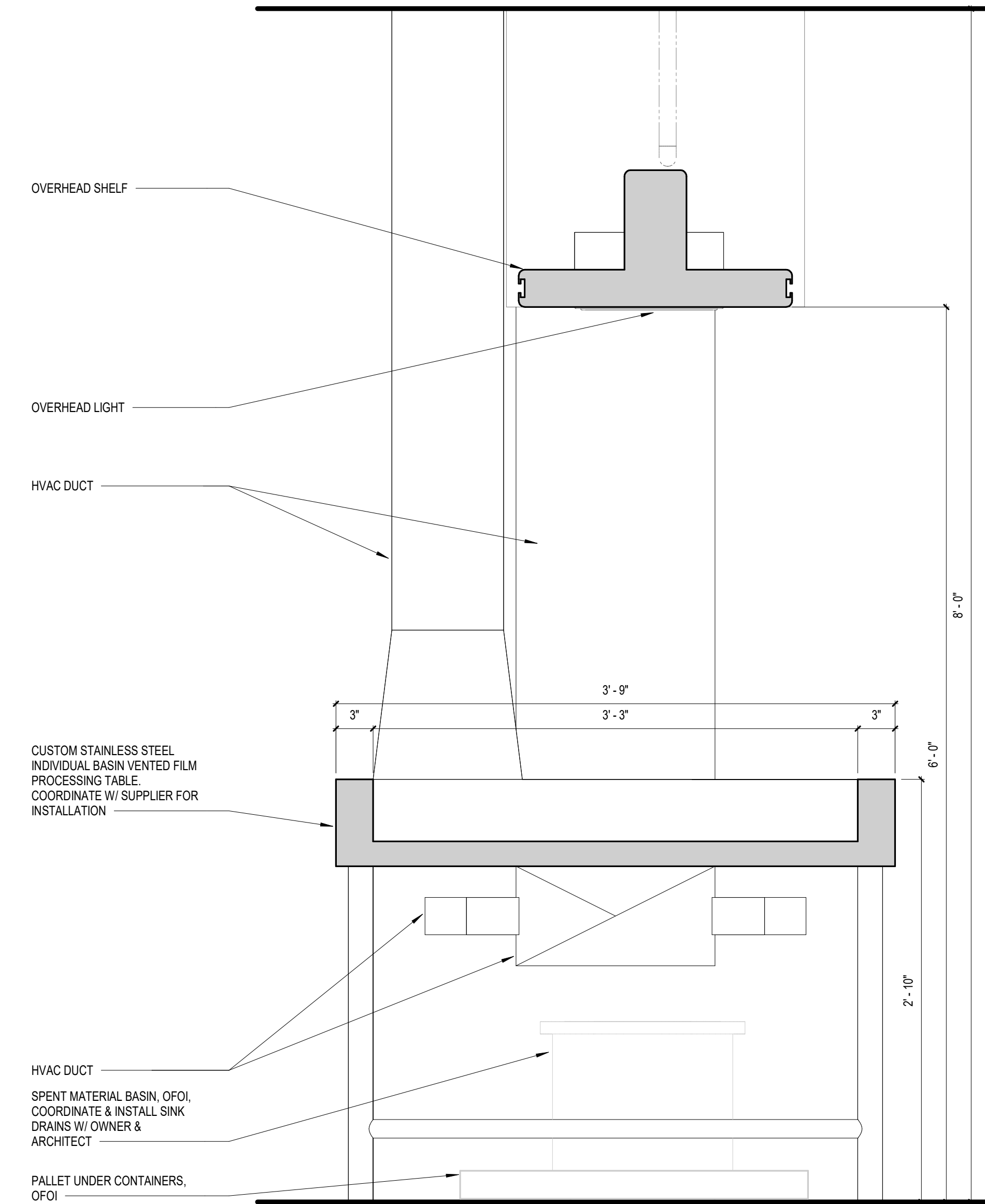

1 PROCESSING SINK DETAIL
1 1/2" = 1'-0"



MSU-CPDC
MONTANA STATE UNIVERSITY
BOZEMAN, MONTANA
PHONE: 406.994.5413
FAX: 406.994.5665

**VISUAL COMMUNICATIONS
DARKROOMS 135 & 138 SINK
REPLACEMENT**
MONTANA STATE UNIVERSITY

BID SET



DRAWN BY: **TB**

REVIEWED BY: **MM**

REV. DESCRIPTION DATE

PPA#20-0006

A/E#23061.01

Consultant #:

**SHEET TITLE
DETAILS**

**SHEET
A401**

DATE
04-25-2024

DIVISION 02 - EXISTING CONDITIONS

SECTION 024100 - DEMOLITION

PART 1 GENERAL

1.01 SECTION INCLUDES

- A. Selective demolition of building elements for alteration purposes.

1.02 RELATED REQUIREMENTS

- A. Section 011000 - Summary: Limitations on Contractor's use of site and premises.
- B. Section 015000 - Temporary Facilities and Controls: Site fences, security, protective barriers, and waste removal.
- C. Section 017000 - Execution and Closeout Requirements: Project conditions; protection of bench marks, survey control points, and existing construction to remain; reinstallation of removed products; temporary bracing and shoring.

PART 3 EXECUTION

2.01 GENERAL PROCEDURES AND PROJECT CONDITIONS

- A. Comply with applicable codes and regulations for demolition operations and safety of adjacent structures and the public.
 - 1. Obtain required permits.
 - 2. Take precautions to prevent catastrophic or uncontrolled collapse of structures to be removed; do not allow worker or public access within range of potential collapse of unstable structures.
 - 3. Provide, erect, and maintain temporary barriers and security devices.
 - 4. Conduct operations to minimize effects on and interference with adjacent structures and occupants.
 - 5. Do not close or obstruct roadways or sidewalks without permits from authority having jurisdiction.
 - 6. Conduct operations to minimize obstruction of public and private entrances and exits. Do not obstruct required exits at any time. Protect persons using entrances and exits from removal operations.
 - 7. Obtain written permission from owners of adjacent properties when demolition equipment will traverse, infringe upon, or limit access to their property.
- B. Do not begin removal until receipt of notification to proceed from Owner.
- C. Protect existing structures and other elements to remain in place and not removed.
 - 1. Provide bracing and shoring.
 - 2. Prevent movement or settlement of adjacent structures.
 - 3. Stop work immediately if adjacent structures appear to be in danger.
- D. Hazardous Materials:
 - 1. If hazardous materials are discovered during removal operations, stop work and notify Architect and Owner; hazardous materials include regulated asbestos containing materials, lead, PCBs, and mercury.
- E. Perform demolition in a manner that maximizes salvage and recycling of materials.
 - 1. Dismantle existing construction and separate materials.
 - 2. Set aside reusable, recyclable, and salvageable materials; store and deliver to collection point or point of reuse.

2.02 EXISTING UTILITIES

- A. Coordinate work with utility companies. Notify utilities before starting work, comply with their requirements, and obtain required permits.
- B. Protect existing utilities to remain from damage.
- C. Do not disrupt public utilities without permit from authority having jurisdiction.
- D. Do not close, shut off, or disrupt existing life safety systems that are in use without at least 7 days prior written notification to Owner.
- E. Do not close, shut off, or disrupt existing utility branches or take-offs that are in use without at least 3 days prior written notification to Owner.
- F. Locate and mark utilities to remain; mark using highly visible tags or flags, with identification of utility type; protect from damage due to subsequent construction, using substantial barricades if necessary.
- G. Remove exposed piping, valves, meters, equipment, supports, and foundations of disconnected and abandoned utilities.

2.03 SELECTIVE DEMOLITION FOR ALTERATIONS

- A. Existing construction and utilities indicated on drawings are based on casual field observation and existing record documents only.
 - 1. Verify construction and utility arrangements are as indicated.
 - 2. Report discrepancies to Architect before disturbing existing installation.
 - 3. Beginning of demolition work constitutes acceptance of existing conditions that would be apparent upon examination prior to starting demolition.
- B. Remove existing work as indicated and required to accomplish new work.
 - 1. Remove items indicated on drawings.
- C. Services including, but not limited to, HVAC, Plumbing, Fire Protection, Electrical, and Telecommunications: Remove existing systems and equipment as indicated.
 - 1. Maintain existing active systems to remain in operation, and maintain access to equipment and operational components.
 - 2. Where existing active systems serve occupied facilities but are to be replaced with new services, maintain existing systems in service until new systems are complete and ready for service.
 - 3. Verify that abandoned services serve only abandoned facilities before removal.
 - 4. Remove abandoned pipe, ducts, conduits, and equipment, including those above accessible ceilings. Remove back to source of supply where possible, otherwise cap stub and tag with identification.
- D. Protect existing work to remain.
 - 1. Prevent movement of structure. Provide shoring and bracing as required.
 - 2. Perform cutting to accomplish removal work neatly and as specified for cutting new work.
 - 3. Repair adjacent construction and finishes damaged during removal work.
 - 4. Patch to match new work.

2.04 DEBRIS AND WASTE REMOVAL

- A. Remove debris, junk, and trash from site.
- B. Leave site in clean condition, ready for subsequent work.
- C. Clean up spillage and wind-blown debris from public and private lands.

DIVISION 09 - FINISHES

SECTION 092116 - GYPSUM BOARD ASSEMBLIES

PART 1 GENERAL

1.01 SECTION INCLUDES

- A. Metal stud wall framing.
- B. Acoustic insulation.
- C. Gypsum wallboard.

1.02 RELATED REQUIREMENTS

1.03 REFERENCE STANDARDS

- A. AISI S220 - North American Standard for Cold-Formed Steel Nonstructural Framing; 2020.

- B. ASTM C840 - Standard Specification for Application and Finishing of Gypsum Board; 2023.
- C. ASTM C1396/C1396M - Standard Specification for Gypsum Board; 2017.
- D. ASTM E413 - Classification for Rating Sound Insulation; 2022.

1.04 ADMINISTRATIVE REQUIREMENTS

- A. Coordination: Coordinate the installation of gypsum board assemblies with size, location, and installation of service utilities.

1.05 SUBMITTALS

- A. See Section 013000 - Administrative Requirements for submittal procedures.
- B. Product Data:
 - 1. Provide data on metal framing, gypsum board, accessories, and joint finishing system.
 - 2. Provide manufacturer's data on partition head to structure connectors, showing compliance with requirements.

1.06 Delivery, Storage, and Handling

- A. See Section 017419 - Construction Waste Management and Disposal for packaging waste requirements.
- B. Store gypsum products and accessories indoors and keep above freezing. Elevate boards above floor, on nonwicking supports, in accordance with manufacturer's recommendations.
- C. Store metal products to prevent corrosion.

PART 2 PRODUCTS

2.01 METAL FRAMING MATERIALS

- A. Material and Product Requirements Criteria: AISI S201.
- B. Steel Sheet: ASTM A1003/A1003M, subject to the ductility limitations indicated in AISI S220 or equivalent.
- C. Nonstructural Framing System Components: AISI S220; galvanized sheet steel, of size and properties necessary to comply with ASTM C754 for the spacing indicated, with maximum deflection of wall framing of L/120 at 5 psf (L/120 at 240 Pa).
 - 1. Studs: C-shaped with knurled or embossed faces.
 - 2. Runners: U shaped, sized to match studs.
 - 3. Furring Members: Hat-shaped sections, minimum depth of 7/8 inch (22 mm).

2.02 BOARD MATERIALS

- A. Manufacturers - Gypsum-Based Board:
 - 1. CertainTeed Corporation; ___; www.certainteed.com/#sle.
 - 2. Georgia-Pacific Gypsum; ___; www.gpgypsum.com/#sle.
 - 3. USG Corporation; ___; www.usg.com/#sle.
- B. Gypsum Wallboard: Paper-faced gypsum panels as defined in ASTM C1396/C1396M; sizes to minimize joints in place; ends square cut.
 - 1. Application: Use for vertical surfaces and ceilings, unless otherwise indicated.
 - 2. Thickness:
 - a. Vertical Surfaces: 5/8 inch (16 mm).

2.03 GYPSUM BOARD ACCESSORIES

- A. Acoustic Insulation: ASTM C665; preformed mineral-fiber, friction fit type, unfaced; thickness 2 inches (51 mm).

PART 3 EXECUTION

3.01 EXAMINATION

- A. Verify that project conditions are appropriate for work of this section to commence.

3.02 FRAMING INSTALLATION

- A. Metal Framing: Install in accordance with ASTM C1007/AISI S220 and manufacturer's instructions.
- B. Studs: Space studs at 16 inches on center (at 406 mm on center).
 - 1. Extend partition framing to structure where indicated and to ceiling in other locations.
 - 2. Partitions Terminating at Ceiling: Attach ceiling runner securely to ceiling track in accordance with manufacturer's instructions.

3.03 JOINT TREATMENT

- A. Paper Faced Gypsum Board: Use paper joint tape, embed with drying type joint compound and finish with drying type joint compound.
- B. Finish gypsum board in accordance with levels defined in ASTM C840, as follows:
 - 1. Level 5: Walls and ceilings to receive semi-gloss or gloss paint finish and other areas specifically indicated.
- C. Tape, fill, and sand exposed joints, edges, and corners to produce smooth surface ready to receive finishes.

3.04 TOLERANCES

- A. Maximum Variation of Finished Gypsum Board Surface from True Flatness: 1/8 inch in 10 feet (3 mm in 3 m) in any direction.

3.05 Protection

- A. Protect installed gypsum board assemblies from subsequent construction operations.

SECTION 095100 - ACOUSTICAL CEILINGS

PART 1 GENERAL

1.01 SECTION INCLUDES

- A. Suspended metal grid ceiling system.
- B. Acoustical units.

1.02 REFERENCE STANDARDS

- A. ASTM C635/C635M - Standard Specification for Manufacture, Performance, and Testing of Metal Suspension Systems for Acoustical Tile and Lay-in Panel Ceilings; 2022.
- B. ASTM E1264 - Standard Classification for Acoustical Ceiling Products; 2023.

1.03 ADMINISTRATIVE REQUIREMENTS

- A. Sequence work to ensure acoustical ceilings are not installed until building is enclosed, sufficient heat is provided, dust generating activities have terminated, and overhead work is completed, tested, and approved.
- B. Do not install acoustical units until after interior wet work is dry.

1.04 SUBMITTALS

- A. See Section 013000 - Administrative Requirements for submittal procedures.
- B. Samples: Submit ___ samples 6 by 6 inch in size illustrating material and finish of acoustical units.
- C. Manufacturer's qualification statement.
- D. Maintenance Materials: Furnish the following for Owner's use in maintenance of project.
 - 1. See Section 016000 - Product Requirements, for additional provisions.
 - 2. Extra Acoustical Units: Quantity equal to 5 percent of total installed.

PART 2 PRODUCTS

2.01 MANUFACTURERS

- A. Acoustic Tiles/Panels:
 - 1. Armstrong World Industries, Inc; ___; www.armstrongceilings.com/#sle.
 - 2. Acoustic Ceiling Products, Inc; ___; www.acpideas.com/#sle.
 - 3. Acoustics First Corporation; ___; www.acousticsfirst.com/#sle.
 - 4. Or approved equal, match existing.

2.02 ACOUSTICAL UNITS

- A. Acoustical Panels, Type ___: Painted mineral fiber, with the following characteristics:
 - 1. Application(s): Lab Room.
 - 2. Classification: ASTM E1264 Type III.
 - 3. Size: 24 by 24 inches.
 - 4. Thickness: 3/4 inch.
 - 5. Panel Edge: Square.
 - 6. Color: White.
 - 7. Suspension System: Exposed grid.

2.03 SUSPENSION SYSTEM(S)

- A. Metal Suspension Systems - General: Complying with ASTM C635/C635M; die cut and interlocking components, with perimeter moldings, hold down clips, stabilizer bars, clips, and splices as required.
- B. Metal Suspension Systems - General: Complying with ASTM C635/C635M; die cut and interlocking components, with perimeter moldings, hold down clips, stabilizer bars, clips, and splices as required.

PART 3 EXECUTION

3.01 EXAMINATION

- A. Verify existing conditions before starting work.
- B. Verify that layout of hangers will not interfere with other work.

3.02 Preparation

- A. Install after major above-ceiling work is complete.
- B. Coordinate the location of hangers with other work.

3.03 INSTALLATION - SUSPENSION SYSTEM

- A. Rigidly secure system, including integral mechanical and electrical components, for maximum deflection of 1:360.
- B. Suspension System, Non-Seismic: Hang suspension system independent of walls, columns, ducts, pipes and conduit. Where carrying members are spliced, avoid visible displacement of face plane of adjacent members.
- C. Where ducts or other equipment prevent the regular spacing of hangers, reinforce the nearest affected hangers and related carrying channels to span the extra distance.
- D. Do not support components on main runners or cross runners if weight causes total dead load to exceed deflection capability.
- E. Support fixture loads using supplementary hangers located within 6 inches of each corner, or support components independently.
- F. Do not eccentrically load system or induce rotation of runners.

3.04 INSTALLATION - ACOUSTICAL UNITS

- A. Install acoustical units in accordance with manufacturer's instructions.
- B. Fit acoustical units in place, free from damaged edges or other defects detrimental to appearance and function.
- C. Fit border trim neatly against abutting surfaces.
- D. Install acoustical units level, in uniform plane, and free from twist, warp, and dents.
- E. Cutting Acoustical Units:
 - 1. Cut to fit irregular grid and perimeter edge trim.
 - 2. Make field cut edges of same profile as factory edges.
 - 3. Double cut and field paint exposed reveal edges.

3.05 CLEANING

- A. See Section 017000 - Execution and Closeout Requirements for additional requirements.
- B. Clean surfaces.
- C. Replace damaged or abraded components.

SECTION 096500 - RESILIENT FLOORING

PART 1 GENERAL

1.01 SECTION INCLUDES

- A. Resilient sheet flooring.
- B. Resilient base.
- C. Installation accessories.

1.02 RELATED REQUIREMENTS

1.03 REFERENCE STANDARDS

- A. ASTM F1861 - Standard Specification for Resilient Wall Base; 2021.
- B. ASTM F1913 - Standard Specification for Vinyl Sheet Floor Covering Without Backing; 2019.

1.04 SUBMITTALS

- A. See Section 013000 - Administrative Requirements for submittal procedures.
- B. Product Data: Provide data on specified products, describing physical and performance characteristics; including sizes, patterns and colors available; and installation instructions.
- C. Verification Samples: Submit two samples, 6 by 6 inch in size illustrating color and pattern for each resilient flooring product specified.
- D. Maintenance Materials: Furnish the following for Owner's use in maintenance of project.
 - 1. See Section 016000 - Product Requirements, for additional provisions.
 - 2. Extra Flooring Material: ___ square feet of each type and color.
 - 3. Extra Wall Base: ___ linear feet of each type and color.

1.05 QUALITY ASSURANCE

- A. Manufacturer Qualifications: Company specializing in manufacturing specified flooring with minimum three years documented experience.

1.06 FIELD CONDITIONS



MSU-CPDC
MONTANA STATE UNIVERSITY
BOZEMAN, MONTANA
PHONE: 406.994.5413
FAX: 406.994.5665

**VISUAL COMMUNICATIONS
DARKROOMS 135 & 138 SINK
REPLACEMENT
MONTANA STATE UNIVERSITY**



DRAWN BY: Author		
REVIEWED BY: Checker		
REV.	DESCRIPTION	DATE

PPA#20-0006

A/E#23061.01

Consultant #:

**SHEET TITLE
SPECIFICATIONS**

**SHEET
A801**

**DATE
04-25-2024**

BID SET

- A. Store materials for not less than 48 hours prior to installation in area of installation at a temperature of 70 degrees F to achieve temperature stability. Thereafter, maintain conditions above 55 degrees F.

PART 2 PRODUCTS

- 2.01 SHEET FLOORING
 - A. Vinyl Sheet Flooring - Type ____: Homogeneous without backing, with color and pattern throughout full thickness.
 - 1. Manufacturers:
 - a. Mohawk; www.mohawkgroup.com.
 - 2. Minimum Requirements: Comply with ASTM F1913.
 - 3. Thickness: 0.080 inch nominal.
 - 4. Color: As indicated on drawings.

- 2.02 RESILIENT BASE
 - A. Resilient Base: ASTM F1861, Type TS, rubber, vulcanized thermoset. Style to match existing base.
 - 1. Manufacturers:
 - a. Flexco Corporation; Base Sculptures: www.flexcofloors.com/#sle.
 - b. Johnsonite, a Tarkett Company; : www.johnsonite.com/#sle.
 - c. Mannington Commercial; : www.manningtoncommercial.com/#sle.
 - d. Roppe Corporation; Contours Profiled Wall Base System: www.roppe.com/#sle.
 - e. Or approved equal..
 - 2. Height: 4 inches.
 - 3. Thickness: 0.125 inch.
 - 4. Finish: Satin.

- 2.03 ACCESSORIES
 - A. Primers, Adhesives, and Seam Sealer: Waterproof; types recommended by flooring manufacturer.

PART 3 EXECUTION

- 3.01 EXAMINATION
 - A. Verify that surfaces are flat to tolerances acceptable to flooring manufacturer, free of cracks that might telegraph through flooring, clean, dry, and free of curing compounds, surface hardeners, and other chemicals that might interfere with bonding of flooring to substrate.
 - B. Verify that wall surfaces are smooth and flat within the tolerances specified for that type of work, are dust-free, and are ready to receive resilient base.

- 3.02 PREPARATION
 - A. Prepare floor substrates as recommended by flooring and adhesive manufacturers.
 - B. Remove subfloor ridges and bumps. Fill minor low spots, cracks, joints, holes, and other defects with subfloor filler to achieve smooth, flat, hard surface.
 - C. Prohibit traffic until filler is fully cured.
 - D. Clean substrate.

- 3.03 Installation - General
 - A. Starting installation constitutes acceptance of subfloor conditions.
 - B. Install in accordance with manufacturer's written instructions.
 - C. Adhesive-Applied Installation:
 - 1. Spread only enough adhesive to permit installation of materials before initial set.
 - 2. Fit joints and butt seams tightly.
 - 3. Set flooring in place, press with heavy roller to attain full adhesion.
 - D. Loose-Laid Installation: Set flooring in place in accordance with manufacturer's instructions.
 - E. Where type of floor finish, pattern, or color are different on opposite sides of door, terminate flooring under centerline of door.

- 3.04 Installation - Sheet Flooring
 - A. Lay flooring with joints and seams parallel to longer room dimensions, to produce minimum number of seams. Lay out seams to avoid widths less than 1/3 of roll width; match patterns at seams.
 - B. Cut sheet at seams in accordance with manufacturer's instructions.

- 3.05 Installation - Resilient Base
 - A. Fit joints tightly and make vertical. Maintain minimum dimension of 18 inches between joints.
 - B. Install base on solid backing. Bond tightly to wall and floor surfaces.

- 3.06 CLEANING
 - A. Remove excess adhesive from floor, base, and wall surfaces without damage.
 - B. Clean in accordance with manufacturer's written instructions.

- 3.07 PROTECTION
 - A. Prohibit traffic on resilient flooring for 48 hours after installation.

SECTION 099123 - INTERIOR PAINTING

PART 1 GENERAL

- 1.01 SECTION INCLUDES
 - A. Surface preparation.
 - B. Field application of paints.
 - C. Scope: Finish interior surfaces exposed to view, unless fully factory-finished and unless otherwise indicated.
 - D. Do Not Paint or Finish the Following Items:
 - 1. Items factory-finished unless otherwise indicated; materials and products having factory-applied primers are not considered factory finished.
 - 2. Items indicated to receive other finishes.
 - 3. Items indicated to remain unfinished.
 - 4. Fire rating labels, equipment serial number and capacity labels, bar code labels, and operating parts of equipment.
 - 5. Floors, unless specifically indicated.
 - 6. Glass.
 - 7. Concealed pipes, ducts, and conduits.

- 1.02 REFERENCE STANDARDS
 - A. MPI (APSM) - Master Painters Institute Architectural Painting Specification Manual; Current Edition.

- 1.03 SUBMITTALS
 - A. See Section 013000 - Administrative Requirements, for submittal procedures.
 - B. Product Data: Provide complete list of products to be used, with the following information for each:
 - 1. Manufacturer's name, product name and/or catalog number, and general product category (e.g., "alkyd enamel").
 - 2. MPI product number (e.g., MPI #47).

- 1.04 QUALITY ASSURANCE
 - A. Manufacturer Qualifications: Company specializing in manufacturing the products specified, with minimum three years documented experience.

- 1.05 DELIVERY, STORAGE, AND HANDLING
 - A. Container Label: Include manufacturer's name, type of paint, brand name, lot number, brand code, coverage, surface preparation, drying time, cleanup requirements, color designation, and instructions for mixing and reducing.
 - B. Paint Materials: Store at minimum ambient temperature of 45 degrees F (7 degrees C) and a maximum of 90 degrees F (32 degrees C), in ventilated area, and as required by manufacturer's instructions.

PART 2 PRODUCTS

- 2.01 MANUFACTURERS
 - A. Provide paints and finishes from the same manufacturer to the greatest extent possible.
 - B. Paints:
 - 1. Behr Process Corporation: www.behr.com/#sle.
 - 2. PPG Paints: www.ppgpaints.com/#sle.
 - 3. Sherwin-Williams Company: www.sherwin-williams.com/#sle.

- 2.02 PAINTS AND FINISHES - GENERAL
 - A. Paints and Finishes: Ready-mixed, unless intended to be a field-catalyzed paint.
 - B. Volatile Organic Compound (VOC) Content:
 - 1. Provide paints and finishes that comply with the most stringent requirements specified in the following:
 - a. Architectural coatings VOC limits of 0.
 - 2. Determination of VOC Content: Testing and calculation in accordance with 40 CFR 59, Subpart D (EPA Method 24), exclusive of colorants added to a tint base and water added at project site; or other method acceptable to authorities having jurisdiction.
 - C. Colors: To be selected from manufacturer's full range of available colors.

2.03 PAINT SYSTEMS - INTERIOR

- A. Paint I-OP - Interior Surfaces to be Painted, Unless Otherwise Indicated: Including gypsum board, concrete, concrete masonry units, brick, wood, plaster, uncoated steel, shop primed steel, galvanized steel, aluminum, and acoustical ceilings.
 - 1. Two top coats and one coat primer.
 - 2. Top Coat(s): Institutional Low Odor/VOC Interior Latex; MPI #143, 144, 145, 146, 147, or 148.
 - 3. Top Coat Sheen:
 - a. Semi-Gloss: MPI gloss level 5; use this sheen at all locations.
- B. Paint I-OP-MD-DT - Medium Duty Door/Trim: For surfaces subject to frequent contact by occupants, including metals:
 - 1. Medium duty applications include doors and door frames.
 - 2. Two top coats and one coat primer.

- 2.04 PRIMERS
 - A. Primers: Provide the following unless other primer is required or recommended by manufacturer of top coats.
 - 1. Interior Institutional Low Odor/VOC Primer Sealer; MPI #149.

PART 3 EXECUTION

- 3.01 EXAMINATION
 - A. Do not begin application of paints and finishes until substrates have been adequately prepared.
 - B. Verify that surfaces are ready to receive work as instructed by the product manufacturer.
 - C. Examine surfaces scheduled to be finished prior to commencement of work. Report any condition that may potentially affect proper application.
 - D. Measure moisture content of surfaces using an electronic moisture meter. Do not apply finishes unless moisture content of surfaces is below the following maximums:
 - 1. Gypsum Wallboard: 12 percent.

- 3.02 PREPARATION
 - A. Clean surfaces thoroughly and correct defects prior to application.
 - B. Prepare surfaces using the methods recommended by the manufacturer for achieving the best result for the substrate under the project conditions.
 - C. Gypsum Board: Fill minor defects with filler compound. Spot prime defects after repair.

- 3.03 APPLICATION
 - A. Apply products in accordance with manufacturer's written instructions and recommendations in "MPI Architectural Painting Specification Manual".

- 3.04 CLEANING
 - A. Collect waste material that could constitute a fire hazard, place in closed metal containers, and remove daily from site.

- 3.05 PROTECTION
 - A. Touch-up damaged finishes after Substantial Completion.

DIVISION 10 - SPECIALTIES

SECTION 102600 - WALL AND DOOR PROTECTION

PART 1 GENERAL

- 1.01 SECTION INCLUDES
 - A. Protective wall covering.
- 1.02 SUBMITTALS
 - A. See Section 013000 - Administrative Requirements for submittal procedures.
 - B. Product Data: Indicate physical dimensions, features, wall mounting brackets with mounted measurements, anchorage details, and rough-in measurements.
 - C. Samples: Submit samples illustrating component design, configurations, joinery, color and finish.
 - D. Manufacturer's Instructions: Indicate special procedures, perimeter conditions requiring special attention, and ____.
 - E. Warranty Documentation: Submit manufacturer warranty and ensure that forms have been completed in Owner's name and registered with manufacturer.
 - F. Maintenance Materials: Furnish the following for Owner's use in maintenance of project:
 - 1. See Section 016000 - Product Requirements, for additional provisions.
 - G. Maintenance Data: Manufacturer's instructions for care and cleaning of each type of product. Include information about both recommended and potentially detrimental cleaning materials and methods.

- 1.03 DELIVERY, STORAGE, AND HANDLING
 - A. Deliver wall and door protection items in original, undamaged protective packaging. Label items to designate installation locations.
 - B. Store products in either horizontal or vertical position, in compliance with manufacturer's instructions.

PART 2 PRODUCTS

- 2.01 MANUFACTURERS
 - A. Protective Wall Covering:
 - 1. Inpro: ____; www.inprocorp.com/#sle.

- 2.02 PRODUCT TYPES
 - A. Protective Wall Covering:
 - 1. Material: High-impact acrylic-modified vinyl.
 - 2. Thickness: 0.040 inch.
 - 3. Color: As selected from manufacturer's standard colors.
 - 4. Accessories: Provide manufacturer's standard color-matched trim and moldings.
 - a. Inside Corner Trim: Standard angle
 - b. Outside Corner Trim: Standard angle.
 - 5. Mounting: Adhesive.

- 2.03 FABRICATION
 - A. Fabricate components with tight joints, corners and seams.

PART 3 EXECUTION

- 3.01 EXAMINATION
 - A. Verify that rough openings, concealed blocking, and anchors are correctly sized and located.
- 3.02 INSTALLATION
 - A. Install components in accordance with manufacturer's instructions, level and plumb, secured rigidly in position to supporting construction.
- 3.03 CLEANING
 - A. Clean wall and door protection items of excess adhesive, dust, dirt, and other contaminants.

DIVISION 12 - FURNISHINGS

SECTION 122216 - DRAPERY TRACK AND ACCESSORIES

PART 1 GENERAL

- 1.01 SECTION INCLUDES
 - A. Formed steel track.
 - B. Nylon carriers, cords, and accessories.

- 1.02 REFERENCE STANDARDS
 - A. WCMA A100.1 - Standard for Safety of Window Covering Products; 2022.

PART 2 PRODUCTS

- 2.01 MANUFACTURERS
 - A. Drapery Track:
 - 1. Steel Guard; www.steelguardsafety.com.
 - 2. Or approved equal..
 - 3. Substitutions: See Section 016000 - Product Requirements.

- 2.02 COMPONENTS
 - A. Tracks: Formed steel, side stacking operating traverse rods, heavy duty channel track.
 - B. Track Brackets: Formed steel ceiling type, for ____ installation, with screws and inserts for attachment.
 - C. Curtains: Industrial Blackout, floor to ceiling.
 - D. Carriers: Nylon roller 3 per foot, ____ type.
 - E. Cord: Braided nylon; continuous loop, free end weighted, complying with WCMA A100.1.

- 2.03 FINISHES
 - A. Exposed Surfaces: Baked enamel, ____.

PART 3 EXECUTION

- 3.01 INSTALLATION
 - A. Install drapery tracks in accordance with manufacturer's instructions.
 - B. Mount track support brackets on solid backing. Where mounting location does not align with solid backing, provide expanding anchors for each screw hole location.

SECTION 123600 - COUNTERTOPS

PART 1 GENERAL

- 1.01 SECTION INCLUDES
 - A. Wall-hung counters and vanity tops.
- 1.02 REFERENCE STANDARDS
 - A. AWI/AWMA/WI (AWS) - Architectural Woodwork Standards, 2nd Edition; 2014, with Errata (2016).
 - B. AWMA/WI (NAAWS) - North American Architectural Woodwork Standards; 2021, with Errata.
 - C. ISFA 2-01 - Classification and Standards for Solid Surfacing Material; 2013.
 - D. NEMA LD 3 - High-Pressure Decorative Laminates; 2005.
 - E. PS 1 - Structural Plywood; 2023.
 - F. SEFA 2 - Installations; 2010.
- 1.03 SUBMITTALS
 - A. See Section 013000 - Administrative Requirements for submittal procedures.
 - B. Product Data: Manufacturer's data sheets on each product to be used, including:
 - 1. Preparation instructions and recommendations.
 - 2. Storage and handling requirements and recommendations.
 - 3. Specimen warranty.
 - C. Shop Drawings: Complete details of materials and installation ; combine with shop drawings of cabinets and casework specified in other sections.



MSU-CPDC
MONTANA STATE UNIVERSITY
BOZEMAN, MONTANA
PHONE: 406.994.5413
FAX: 406.994.5665

BID SET
VISUAL COMMUNICATIONS
DARKROOMS 135 & 138 SINK
REPLACEMENT
MONTANA STATE UNIVERSITY



DRAWN BY: Author		
REVIEWED BY: Checker		
REV.	DESCRIPTION	DATE

PPA#20-0006
A/E#23061.01
Consultant #:

SHEET TITLE
SPECIFICATIONS

SHEET
A802

DATE
04-25-2024

- D. Selection Samples: For each finish product specified, color chips representing manufacturer's full range of available colors and patterns.
- E. Test Reports: Chemical resistance testing, showing compliance with specified requirements.
- F. Certificate: Submit labels and certificates required by quality assurance and quality control programs.

1.04 QUALITY ASSURANCE

- A. Quality Certification:
 - 1. Provide labels or certificates indicating that the installed work complies with AWI/AWMAC/WI (AWS) or AWMAC/WI (NAAWS) requirements for grade or grades specified.
 - 2. Provide designated labels on shop drawings as required by certification program.
 - 3. Provide designated labels on installed products as required by certification program.
 - 4. Submit certifications upon completion of installation that verifies this work is in compliance with specified requirements.

PART 2 PRODUCTS

2.01 COUNTERTOPS

- A. Solid Surfacing Countertops: Solid surfacing sheet or plastic resin casting over continuous substrate.
 - 1. Flat Sheet Thickness: 1/2 inch, minimum.
 - 2. Solid Surfacing Sheet and Plastic Resin Castings: Complying with ISFA 2-01 and NEMA LD 3; acrylic or polyester resin, mineral filler, and pigments; homogenous, non-porous and capable of being worked and repaired using standard woodworking tools; no surface coating; color and pattern consistent throughout thickness.
 - a. Manufacturers:
 - 1) Avonite Surfaces; _____: www.avonitesurfaces.com/#sle.
 - 2) Dupont; _____: www.corian.com/#sle.
 - 3) Formica Corporation; _____: www.formica.com/#sle.
 - 4) LG Hausys America, Inc; HI-MACS 12mm: www.lghausysusa.com/#sle.
 - 5) Wilsonart; _____: www.wilsonart.com/#sle.
 - 6) Or approved equal.
 - b. Finish on Exposed Surfaces: Matte, gloss rating of 5 to 20.
 - c. Color and Pattern: As selected by Architect from manufacturer's full line.
 - 3. Other Components Thickness: 1/2 inch, minimum.
 - 4. Back and End Splashes: Same sheet material, square top; minimum 4 inches high.

2.02 MATERIALS

- A. Plywood for Supporting Substrate: PS 1 Exterior Grade, A-C veneer grade, minimum 5-ply; minimum 3/4 inch thick; join lengths using metal splines.
- B. Adhesives: Chemical resistant waterproof adhesive as recommended by manufacturer of materials being joined.
- C. Joint Sealant: Mildew-resistant silicone sealant, clear.

2.03 FABRICATION

- A. Fabricate tops and splashes in the largest sections practicable, with top surface of joints flush.
 - 1. Join lengths of tops using best method recommended by manufacturer.
 - 2. Fabricate to overhang fronts and ends of cabinets 1 inch except where top butts against cabinet or wall.
 - 3. Prepare all cutouts accurately to size; replace tops having improperly dimensioned or unnecessary cutouts or fixture holes.
- B. Provide back/end splash wherever counter edge abuts vertical surface unless otherwise indicated.
 - 1. Secure to countertop with concealed fasteners and with contact surfaces set in waterproof glue.
 - 2. Height: 4 inches, unless otherwise indicated.

PART 3 EXECUTION

3.01 EXAMINATION

- A. Do not begin installation until substrates have been properly prepared.
- B. If substrate preparation is the responsibility of another installer, notify Architect of unsatisfactory preparation before proceeding.
- C. Verify that wall surfaces have been finished and mechanical and electrical services and outlets are installed in proper locations.

3.02 PREPARATION

- A. Clean surfaces thoroughly prior to installation.
- B. Prepare surfaces using the methods recommended by the manufacturer for achieving the best result for the substrate under the project conditions.

3.03 INSTALLATION

- A. Install laboratory worksurface countertops in compliance with requirements of SEFA 2.
- B. Securely attach countertops to cabinets using concealed fasteners. Make flat surfaces level; shim where required.
- C. Seal joint between back/end splashes and vertical surfaces.



MSU-CPDC
MONTANA STATE UNIVERSITY
BOZEMAN, MONTANA
PHONE: 406.994.5413
FAX: 406.994.5665

VISUAL COMMUNICATIONS
DARKROOMS 135 & 138 SINK
REPLACEMENT
MONTANA STATE UNIVERSITY

BID SET



DRAWN BY: **Author**
REVIEWED BY: **Checker**

REV.	DESCRIPTION	DATE
△		

PPA#20-0006

A/E#23061.01

Consultant #:

SHEET TITLE
SPECIFICATIONS

SHEET
A803

DATE
04-25-2024

ABBREVIATIONS

ACC	AIR COOLED CONDENSER	ID	INSIDE DIAMETER
ACU	AIR CONDITIONING UNIT	IFB	INTEGRAL FACE & BYPASS
AD	ACCESS DOOR	IGV	INLET GUIDE VANES
ADJ	ADJUSTABLE	IPS	IRON PIPE SIZE
AF	AIR FOIL	IU	INDUCTION UNIT
AFB	ABOVE FINISHED FLOOR	KW	KILOWATTS
AFG	ABOVE FINISHED GRADE	KWH	KILOWATT HOUR
AFR	ABOVE FINISHED ROOF		
AFS	AIR FLOW STATION		
AHU	AIR HANDLING UNIT	LAT	LEAVING AIR TEMPERATURE (°F)
AP	ACCESS PANEL	LF	LINEAR FEET
ATC	AUTOMATIC TEMPERATURE CONTROL	LWT	LEAVING WATER TEMPERATURE (°F)
ATM	ATMOSPHERE		
AWG	AMERICAN WIRE GAUGE	M	MOTOR OPERATED
		MAU	MAKEUP AIR UNIT
B	BOILER	MB	MIXING BOX
BB	BASEBOARD	MBH	1000 BTU/HR
BC	BACKWARD CURVED	MC	MECHANICAL CONTRACTOR
BD	BACKDRAFT DAMPER	MFR	MANUFACTURER
BF	BOILER FEED	MS	MINI-SPLIT
BHP	BRAKE HORSEPOWER		
BI	BACKWARD INCLINED	NC	NOISE CRITERIA
BMS	BUILDING MANAGEMENT SYSTEM	NC	NORMALLY CLOSED
BOD	BOTTOM OF DUCT	NC	NOT IN CONTRACT
BOJ	BOTTOM OF JOIST	NO	NORMALLY OPEN
BOS	BOTTOM OF STEEL	NPS	NOMINAL PIPE SIZE
BTU	BRITISH THERMAL UNIT		
		OA	OUTSIDE AIR
C	COMMON	OAD	OUTSIDE AIR DAMPER
CAV	CONSTANT AIR VOLUME	OBD	OPPOSED BLADE DAMPER
CC	COOLING COIL		
CCW	COUNTER CLOCKWISE	P	PUMP
CFM	CUBIC FEET PER MINUTE	PC	PLUMBING CONTRACTOR
CH	CHILLER	PD	PRESSURE DROP
C&I	CONTROLS & INSTRUMENTATION	PH	PHASE
CLG	CEILING	PHC	PREHEAT COIL
CMU	CONCRETE MASONRY UNIT	PFM	PART PER MILLION
CND	CONDENSATE	PROP	PROPELLER
CONT	CONTINUATION	PRV	PRESSURE REDUCING VALVE
CORR	CORRIDOR	PSIA	PSI, ABSOLUTE
CT	COOLING TOWER	PSIG	PSI, GAUGE
CU	CONDENSING UNIT	QTY	QUANTITY
CH	CABINET HEATER		
CV	CONTROL VALVE	R	REGISTER
CVS	CONTROL VALVE STATION	RA	RETURN AIR
CW	CLOCKWISE	R	RADIAL DAMPER
		RD	RETURN/RELEASE AIR FAN
dB	DECIBEL	RH	RELATIVE HUMIDITY
DB	DRY BULB TEMPERATURE (°F)	RHC	REHEAT COIL
DDC	DIRECT DIGITAL CONTROL		
DH	DUCT HEATER	SA	SUPPLY AIR
DP	DEW POINT TEMPERATURE (°F)	SAF	SUPPLY AIR FAN
DX	DIRECT EXPANSION	SC	SENSIBLE COOLER
		SCFM	CFM, STANDARD CONDITIONS
E	EXHAUST	SD	SMOKE DETECTOR
EA	EXHAUST AIR	SEER	SEASONAL ENERGY EFFICIENCY RATIO
EAT	ENTERING AIR TEMPERATURE (°F)	SENS	SENSIBLE
EC	ELECTRICAL CONTRACTOR	SP	STATIC PRESSURE
EDR	EQUIVALENT DIRECT RADIATION	SPS	STATIC PRESSURE SENSOR
EER	ENERGY EFFICIENCY RATIO	SS	STAINLESS STEEL
EF	EXHAUST FAN		
EFF	EFFICIENCY	T	THERMOSTAT
ELEV	ELEVATION	TA	TRANSFER AIR
ERV	ENERGY RECOVERY VENTILATOR	TCC	TEMPERATURE CONTROL CONTRACTOR
ESP	EXTERNAL STATIC PRESSURE	TCP	TEMPERATURE CONTROL PANEL
ET	EXPANSION TANK	TG	TRANSFER GRILL
EWT	ENTERING WATER TEMPERATURE (°F)	TOD	TOP OF DUCT
		TOP	TOP OF PIPE
F&T	FLOAT & THERMOSTATIC	TOS	TOP OF STEEL
FA	FACE AREA	TSP	TOTAL STATIC PRESSURE
FC	FORWARD CURVED	TYP	TYPICAL
FC	FAN COIL		
FP	FIRE PROTECTION	UH	UNIT HEATER
FFM	FEET PER MINUTE	UNC	UNDERCUT
FT	FEET	UV	UNIT VENTILATOR
		VA	VOLT-AMPERE
GA	GAUGE OR GAGE	VAV	VARIABLE AIR VOLUME
GC	GENERAL CONTRACTOR	VD	VOLUME DAMPER
GEN	GENERATOR	VEL	VELOCITY
GH	GRAVITY HOOD	VFD	VARIABLE FREQUENCY DRIVE
GPD	GALLONS PER DAY	VRF	VARIABLE REFRIGERANT FLOW
GPH	GALLONS PER HOUR		
GPM	GALLONS PER MINUTE		
		WB	WET BULB TEMPERATURE (°F)
H	HUMIDIFIER	WC	WATER COLUMN
HC	HEATING COIL	WG	WATER GAUGE
HG	MERCURY	WSHP	WATER SOURCE HEAT PUMP
HOA	HAND-OFF-AUTOMATIC		
HP	HORSEPOWER	ΔT	TEMPERATURE DIFFERENCE (°F)
HR	HOUR		
HX	HEAT EXCHANGER		

MECHANICAL LEGEND

ANNOTATION SYMBOLS

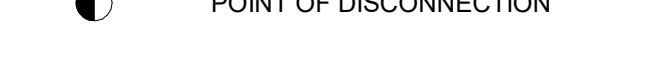
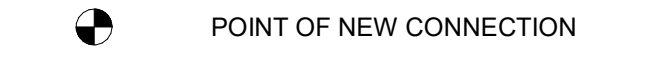
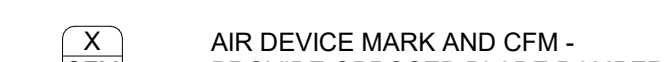
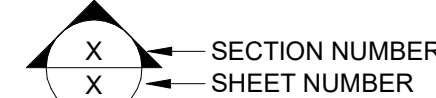
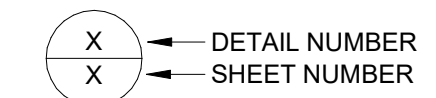
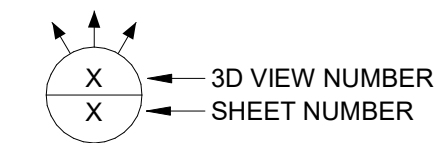

HVAC CONTROL SYMBOLS

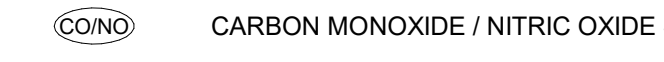
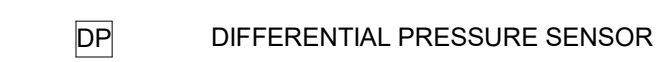
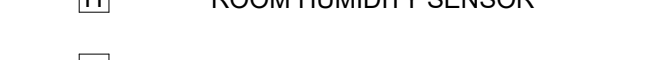
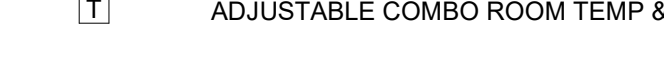
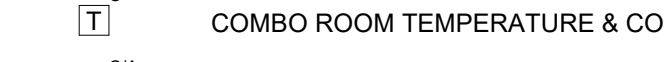
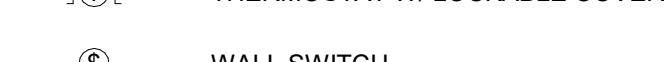
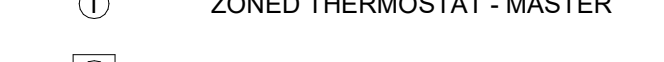
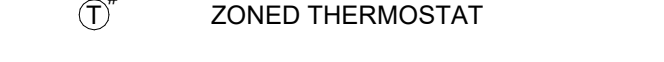
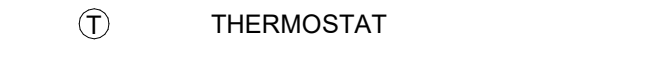

NOTE: THIS IS A STANDARD LEGEND. NOT ALL PIPE TYPES AND SYMBOLS ARE NECESSARILY UTILIZED IN THE DRAWINGS.

HVAC DUCTWORK

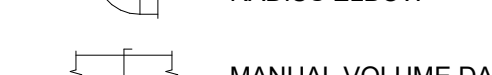
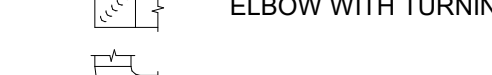
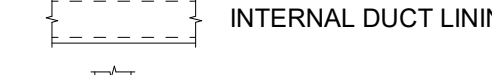
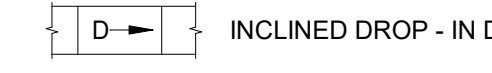
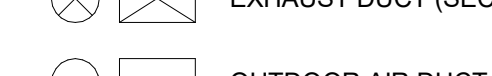

GENERAL

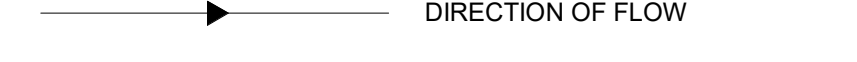

HVAC PIPING

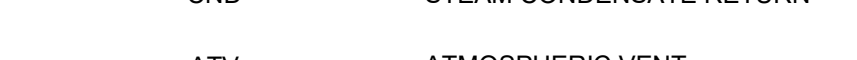
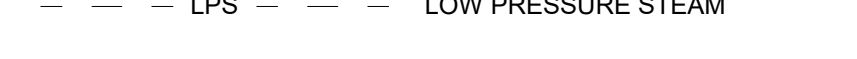
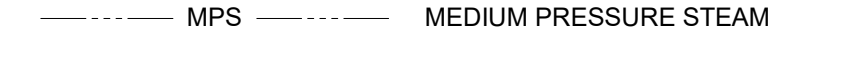
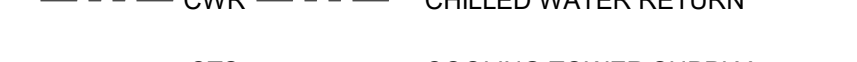
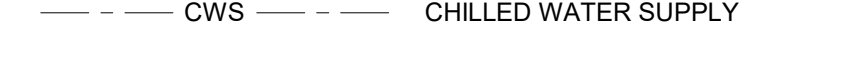
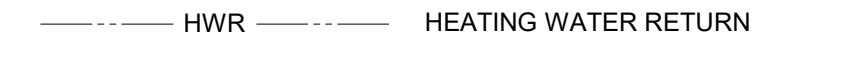

PIPE FITTINGS

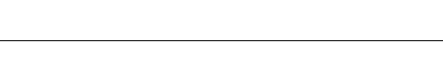
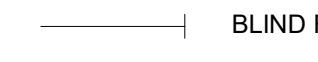
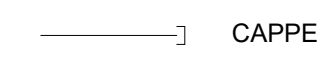
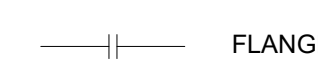
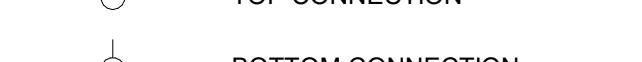
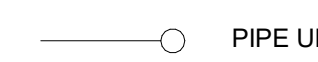

VALVES

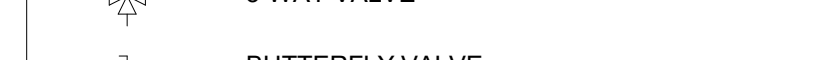

PIPING SPECIALTIES

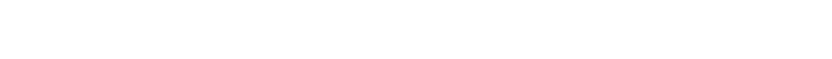
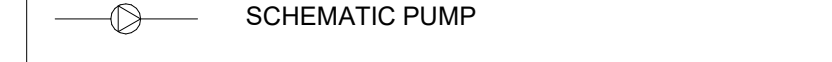
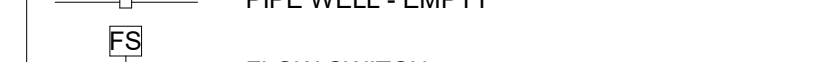
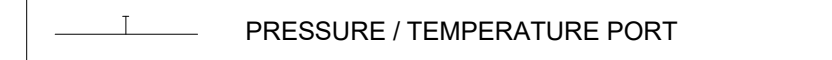

MECH. GENERAL NOTES

- INSTALLATION:**
- NEW PIPING, DUCTWORK AND EQUIPMENT TO BE INSTALLED IN ACCORDANCE WITH THE CURRENTLY ADOPTED INTERNATIONAL MECHANICAL AND INTERNATIONAL BUILDING CODES.
 - EQUIPMENT SHALL BE INSTALLED LEVEL, PLUMB, AND FIRMLY ANCHORED IN LOCATIONS INDICATED ON PLAN. OBSERVE MANUFACTURER'S INSTALLATION INSTRUCTIONS AND RECOGNIZED INDUSTRY PRACTICES TO ENSURE THAT PRODUCTS SERVE THEIR INTENDED FUNCTION.
 - INSTALL EQUIPMENT, DUCTWORK, AND PIPING SO AS TO MAINTAIN CODE REQUIRED CLEARANCES FOR ELECTRICAL AND TELECOMMUNICATION EQUIPMENT.
 - ELEMENTS PENETRATING BUILDING COMPONENTS (ROOF ASSEMBLIES, WALL ASSEMBLIES, ETC.) SHALL BE SEALED WEATHER AND WATER TIGHT. COORDINATE PENETRATIONS WITH GENERAL CONTRACTOR TO PATCH TO THE SATISFACTION OF THE ARCHITECT OR ENGINEER.
 - PER IECC 2021 EQUIPMENT MANUFACTURED AFTER 1/1/2023 SHALL MEET MINIMUM SEER2 RATINGS.

- COORDINATION:**
- IT SHALL BE THE RESPONSIBILITY OF THE MECHANICAL CONTRACTOR TO FIELD COORDINATE THE LOCATION OF EQUIPMENT, ROUTING OF DUCTWORK, AND ROUTING OF PIPING WITH OTHER TRADES.
 - IT SHALL BE THE RESPONSIBILITY OF THE MECHANICAL CONTRACTOR TO REVIEW THE DRAWINGS OF OTHER DISCIPLINES AND PROVIDE THE NECESSARY LABOR AND MATERIALS REQUIRED FOR A COMPLETE INSTALLATION.
 - COORDINATE THE INSTALLATION OF GRILLES, REGISTERS AND DIFFUSERS WITH THE ARCHITECTURAL REFLECTED CEILING PLANS, THE ELECTRICAL LIGHTING PLANS, AND IF RELEVANT, THE TELECOMMUNICATION AND FIRE SPRINKLER PLANS.

- ELECTRICAL COORDINATION:**
- SEE THE MEP COORDINATION SCHEDULE FOR ELECTRICAL INFORMATION. COORDINATE WITH OTHER TRADES TO ENSURE THAT ELECTRICAL DISCONNECTS, MOTOR STARTERS, VARIABLE FREQUENCY DRIVES, CONTROLS, AND ELECTRICAL ACCESSORIES ARE FURNISHED AND/OR INSTALLED BY THE APPROPRIATE TRADE.

- SITE ELEVATION:**
- EQUIPMENT SHALL BE SELECTED FOR THE PROJECT ELEVATION OF 4,900'.

MECH. SHEET INDEX

NUMBER	SHEET NAME
M001	MECHANICAL LEGEND & NOTES
M002	MECHANICAL SPECIFICATIONS
MD100	MECHANICAL DEMO PLAN
M100	MECHANICAL PLAN



MSU-CPDC
MONTANA STATE UNIVERSITY
BOZEMAN, MONTANA
PHONE: 406.994.5413
FAX: 406.994.5665

VISUAL COMMUNICATIONS
DARKROOMS 135 & 138 SINK
REPLACEMENT
MONTANA STATE UNIVERSITY



DRAWN BY: LAG
REVIEWED BY: JRH

REV.	DESCRIPTION	DATE

PPA#20-0006
A/E#23061.01
MMI#6161.011

SHEET TITLE
MECHANICAL
LEGEND & NOTES

SHEET
M001

DATE
04-25-2024

MECHANICAL SPECIFICATIONS

GENERAL

- THE MECHANICAL CONTRACTOR SHALL INCLUDE ALL ITEMS, ARTICLES, MATERIALS, OPERATIONS AND METHODS LISTED, MENTIONED, OR SCHEDULED IN THESE SPECIFICATIONS AND THE ACCOMPANYING DRAWINGS. ALL MATERIAL, EQUIPMENT, AND LABOR SHALL BE FURNISHED TOGETHER WITH ALL INCIDENTAL ITEMS REQUIRED BY GOOD PRACTICE TO PROVIDE THE COMPLETE SYSTEMS DESCRIBED.
- EXAMINE AND REFER TO ALL ARCHITECTURAL, CIVIL, STRUCTURAL, ELECTRICAL, UTILITY, LANDSCAPE AND MECHANICAL DRAWINGS AND SPECIFICATIONS FOR CONSTRUCTION CONDITIONS WHICH MAY AFFECT THE MECHANICAL WORK. INSPECT THE BUILDING SITE AND EXISTING FACILITIES FOR VERIFICATION OF PRESENT CONDITIONS. MAKE PROPER PROVISIONS FOR THESE CONDITIONS IN PERFORMANCE OF THE WORK AND COST THEREOF.
- ALL WORK ON THE PROJECT SHALL CONFORM TO ALL ADOPTED CITY, STATE, AND NATIONAL CODES & REGULATIONS. SUCH CODES & REGULATIONS INCLUDE, BUT ARE NOT LIMITED TO, THE IBC, IMC, IECC, UPC, NFPA, NEC, SERVICING UTILITY COMPANIES AND THE AUTHORITY HAVING JURISDICTION.
- THE MECHANICAL AND ELECTRICAL CONTRACTORS SHALL BE RESPONSIBLE FOR AND PAY FOR ALL FEES AND PERMITS REQUIRED FOR WORK UNDER THEIR CONTRACT AND UNDER THEIR SUPERVISION BY SUBCONTRACT.
- ALL USAGE CONTRACTS BETWEEN THE OWNER AND THE SERVING UTILITIES COMPANY, SUCH AS MEMBERSHIP AND USAGE CHARGES OR FEES, ETC., FOR THE PURPOSE OF OBTAINING THE SERVICES FOR THE UTILITY COMPANY SHALL BE APPLIED FOR AND PAID FOR BY THE OWNER.

RESPONSIBILITY

- THE MECHANICAL CONTRACTOR SHALL BE RESPONSIBLE FOR THE INSTALLATION OF A SATISFACTORY AND COMPLETE SYSTEM IN ACCORDANCE WITH THE INTENT OF THE DRAWING AND SPECIFICATIONS. PROVIDE, AT NO EXTRA COST, ALL INCIDENTAL ITEMS, MATERIALS, ACCESSORIES AND LABOR REQUIRED FOR COMPLETION OF THE WORK EVEN THOUGH THEY ARE NOT SPECIFICALLY MENTIONED OR INDICATED ON THE DRAWINGS OR IN THE SPECIFICATIONS.
- THE DRAWINGS DO NOT ATTEMPT TO SHOW COMPLETE DETAILS OF THE BUILDING CONSTRUCTION WHICH AFFECT THE MECHANICAL INSTALLATION; AND REFERENCE IS THEREFORE REQUIRED TO THE ARCHITECTURAL, CIVIL, STRUCTURAL, LANDSCAPE AND ELECTRICAL DRAWINGS AND SPECIFICATIONS AND TO SHOP DRAWINGS OF ALL TRADES FOR ADDITIONAL DETAILS WHICH AFFECT THE INSTALLATION OF THE WORK COVERED UNDER THIS DIVISION OF THE CONTRACT.
- LOCATION OF MECHANICAL SYSTEM COMPONENTS SHALL BE CHECKED FOR CONFLICTS WITH OPENINGS, STRUCTURAL MEMBERS AND COMPONENTS OF OTHER SYSTEMS HAVING FIXED LOCATIONS. IN THE EVENT OF ANY CONFLICTS, THE ARCHITECT/ENGINEER SHALL BE CONSULTED AND THEIR DECISION SHALL GOVERN. NECESSARY CHANGES SHALL BE MADE AT THE CONTRACTOR'S EXPENSE.
- DO NOT INSTALL EQUIPMENT UNTIL COMPLETE SHOP DRAWINGS OF SUCH EQUIPMENT HAVE BEEN APPROVED BY THE ARCHITECT/ENGINEER. ANY WORK INSTALLED BY THE CONTRACTOR, PRIOR TO APPROVAL OF SHOP DRAWINGS, WILL BE AT THE CONTRACTOR'S RISK.
- ALL MODIFICATIONS AND CHANGES REQUIRED DUE TO INSTALLATION OF EQUIPMENT OTHER THAN THE EQUIPMENT SCHEDULED AND SPECIFIED SHALL BE MADE AT THE CONTRACTOR'S EXPENSE. THIS INCLUDES WORK BY OTHER TRADES. IF THE INSTALLATION OF EQUIPMENT OTHER THAN THE SCHEDULED AND SPECIFIED EQUIPMENT REQUIRES MODIFICATIONS TO STRUCTURE, ELECTRICAL SYSTEMS, PLUMBING SYSTEMS, FIRE PROTECTION OR FIRE ALARM SYSTEMS, ANY AND ALL CHANGES SHALL BE MADE AT THE MECHANICAL CONTRACTORS EXPENSE.
- ALL WORK TO BE PERFORMED SHALL FIRST BE SCHEDULED AND SUBMITTED TO THE OWNER'S REPRESENTATIVE FOR ACCEPTANCE.
- THE CONTRACTOR SHALL BE CAREFUL NOT TO BLOCK ANY PATHS OF EGRESS WHILE PERFORMING THE WORK SPECIFIED.
- THE CONTRACTOR SHALL BE RESPONSIBLE FOR CLEANUP OF ALL MATERIALS RESULTING FROM HIS/HER WORK. CLEANUP SHALL BE PERFORMED TO THE LEVEL OF ACCEPTANCE OF THE OWNER'S REPRESENTATIVE & THE ENGINEER.
- THE CONTRACTOR SHALL GUARANTEE THAT ALL WORK EXECUTED UNDER THEIR CONTRACT SHALL BE FREE OF DEFECTS OF MATERIALS AND WORKMANSHIP FOR A PERIOD OF ONE (1) YEAR FROM THE DATE OF SUBSTANTIAL COMPLETION.

INTENT OF DRAWINGS

- THE DRAWINGS ARE PARTLY DIAGRAMMATIC AND DO NOT NECESSARILY SHOW EXACT LOCATION OF PIPING AND DUCTWORK UNLESS SPECIFICALLY DIMENSIONED. RISER AND OTHER DIAGRAMS ARE SCHEMATIC AND DO NOT NECESSARILY SHOW THE PHYSICAL ARRANGEMENT OF THE EQUIPMENT. THEY SHALL NOT BE USED FOR OBTAINING LINEAL RUNS OF PIPING OR DUCTWORK, NOR SHALL THEY BE USED FOR SHOP DRAWINGS FOR PIPING AND DUCTWORK FABRICATION OR ORDERING. DISCREPANCIES SHOWN ON DIFFERENT PLANS, OR BETWEEN PLANS AND ACTUAL FIELD CONDITIONS SHALL BE BROUGHT TO THE ATTENTION OF THE ARCHITECT/ENGINEER FOR RESOLUTION.

MATERIALS AND EQUIPMENT

- MANUFACTURER'S TRADE NAMES AND CATALOG NUMBERS ARE LISTED TO INDICATE THE QUALITY OF EQUIPMENT OR MATERIALS DESIRED FOR INSTALLATION. ALTERNATIVE EQUIPMENT OR MATERIALS MAY BE SUBMITTED FOR PRIOR APPROVAL BEFORE BIDDING THE PROJECT. NO SUBSTITUTIONS WILL BE ALLOWED AFTER BIDDING.
- WRITTEN PRIOR APPROVAL FOR SUBSTITUTIONS MUST BE SUBMITTED TO AND RECEIVED BY THE ARCHITECT/ENGINEER SEVEN (7) DAYS PRIOR TO BID OPENING. REQUESTS FOR SUBSTITUTION ARE TO BE SUBMITTED SUFFICIENTLY AHEAD OF THE DEADLINE TO GIVE AMPLE TIME FOR EXAMINATION. PRIOR APPROVAL REQUEST FOR SUBSTITUTION MUST INDICATE THE SPECIFIC ITEM OR ITEMS TO BE FURNISHED IN LIEU OF THOSE SCHEDULED, TOGETHER WITH COMPLETE TECHNICAL AND COMPARATIVE DATA ON SCHEDULED ITEMS AND ITEMS PROPOSED FOR SUBSTITUTION.
- HIGH ALTITUDE OPERATION: CAPACITY OF ALL EQUIPMENT IS TO BE SIZED AND MANUFACTURED TO PERFORM AT THE ELEVATION OF THE PROJECT SITE. IF NOT SPECIFICALLY INDICATED IN THE EQUIPMENT SCHEDULE OR IN THE SPECIFICATIONS PROVIDE ALL REQUIRED ACCESSORIES AND EQUIPMENT FOR PROPER OPERATION AT ELEVATION OF THE PROJECT SITE.
- STORE MATERIALS AND EQUIPMENT INDOORS AT THE JOB SITE OR, IF THIS IS NOT POSSIBLE, STORE ON RAISED PLATFORMS AND PROTECT FROM THE WEATHER BY MEANS OF WATERPROOF COVERS. COVERINGS SHALL PERMIT CIRCULATION OF AIR AROUND THE MATERIALS TO PREVENT CONDENSATION OF MOISTURE. SCREEN OR CAP OPENINGS IN EQUIPMENT TO PREVENT THE ENTRY OF VERMIN.
- ALL NEW PIPING SHALL BE IDENTIFIED WITH SETON SET MARK PIPE MARKERS, LETTERED TO MATCH EXISTING - IF APPLICABLE - AND MARKED AT A MAXIMUM OF EVERY 25 FT. ALL NEW VALVES SHALL BE IDENTIFIED WITH BRASS OR ALUMINUM VALVE TAGS.

MATERIALS AND EQUIPMENT (CONT.)

- SEE THE DUCTWORK SCHEDULE AND MECHANICAL PIPING SCHEDULE ON THE DRAWINGS FOR MATERIAL AND INSULATION REQUIREMENTS.
- COORDINATE THE INSTALLATION OF GRILLES, REGISTERS AND DIFFUSERS WITH THE ARCHITECTURAL REFLECTED CEILING PLANS AND THE ELECTRICAL LIGHTING PLANS.
- VERIFY THE LOCATION OF THERMOSTATS AND SENSORS WITH THE ARCHITECT AND ENGINEER PRIOR TO INSTALLATION. INSTALL THERMOSTATS 48" ABOVE FINISHED FLOOR PER ADA REQUIREMENTS.
- PROVIDE AND INSTALL SEISMIC BRACING FOR ALL EQUIPMENT, DUCTWORK AND PIPING PER THE REQUIREMENTS OF THE INTERNATIONAL BUILDING CODE.
- FLEXIBLE DUCTWORK BETWEEN BRANCH DUCTS AND GRILLES, REGISTERS OR DIFFUSERS SHALL BE LIMITED TO 5FT.
- INSTALL ACCESSIBLE PLUMBING FIXTURES IN COMPLIANCE WITH ADA REQUIREMENTS. INSULATE ALL EXPOSED PIPING BELOW ADA ACCESSIBLE FIXTURES.
- INSTALL FLOOR DRAIN STRAINERS AND CLEANOUT COVERS FLUSH AND LEVEL WITH FINISHED FLOOR.
- THE MECHANICAL CONTRACTOR SHALL BE RESPONSIBLE FOR FIRE-CAULKING ALL FIRE-RATED AND SMOKE-RATED WALL PENETRATIONS OF PIPING, DUCTWORK, ETC.
- PROVIDE ACCESS DOORS TO ALLOW SERVICE AND INSPECTION OF EQUIPMENT, VALVES, DAMPERS AND DEVICES INSTALLED ABOVE NON-REMOVABLE CEILINGS.

SHOP DRAWINGS AND SUBMITTALS

- WITHIN 30 DAYS OF AWARDING OF THE CONTRACT, THE MECHANICAL CONTRACTOR SHALL SUBMIT SHOP DRAWINGS AND/OR SUBMITTALS FOR ALL SCHEDULED EQUIPMENT AND MATERIALS INCLUDED IN THE CONSTRUCTION DOCUMENTS.
- ALL SHOP DRAWINGS AND SUBMITTALS SHALL BE IN THE FORM OF ELECTRONICALLY TRANSMITTED PDFS. SHOP DRAWINGS AND SUBMITTALS SHALL INCLUDE SHOP DRAWINGS AND LITERATURE SHOWING ITEMS TO BE USED, SIZE, DIMENSIONS, CAPACITY, ROUGH-IN, AND ANY OTHER INFORMATION NECESSARY FOR A COMPLETE REVIEW. MANUFACTURER'S LITERATURE SHOWING MORE THAN ONE ITEM SHALL BE CLEARLY MARKED AS TO WHICH ITEM IS BEING FURNISHED OR IT WILL BE REJECTED AND RETURNED WITHOUT REVIEW.
- EACH SUBMITTED ITEM MUST BE CLEARLY MARKED WITH THE PROJECT NAME, DATE, BRANCH OF WORK, SUBMITTING PARTY, REVISION NUMBER, AND ASSOCIATED SCHEDULE. SUBMITTALS NOT IDENTIFIED AS DESCRIBED ABOVE WILL BE REJECTED AND RETURNED WITHOUT REVIEW.
- PRIOR TO THEIR SUBMISSION, EACH SUBMITTAL SHALL BE THOROUGHLY CHECKED BY THE CONTRACTOR FOR COMPLIANCE WITH THE CONTRACT DOCUMENT REQUIREMENTS. EACH SUBMITTAL SHALL THEN BEAR A STAMP EVIDENCING SUCH CHECKING AND SHALL SHOW CORRECTIONS MADE. IF ANY SUBMITTALS REQUIRING EXTENSIVE CORRECTIONS SHALL BE REVISED BEFORE SUBMISSION TO THE ENGINEER. EACH SUBMITTAL NOT STAMPED AND SIGNED BY THE CONTRACTOR EVIDENCING SUCH CHECKING WILL BE REJECTED AND RETURNED WITHOUT REVIEW.
- REVIEW OF THE SHOP DRAWINGS AND LITERATURE BY THE ENGINEER SHALL NOT RELIEVE THE CONTRACTOR FOR RESPONSIBILITY FOR DEVIATIONS FROM THE DRAWINGS OR SPECIFICATIONS. NOR SHALL IT RELIEVE THE CONTRACTOR FROM RESPONSIBILITY FOR ERRORS IN THE SHOP DRAWINGS OR LITERATURE. IT IS THE RESPONSIBILITY OF THE CONTRACTOR TO PROVIDE MATERIALS AND EQUIPMENT WHICH MEET THE SPECIFICATIONS AND JOB REQUIREMENTS.

REVIEW & SITE INSPECTIONS

- ALL WORK AND MATERIAL IS SUBJECT TO REVIEW AT ANY TIME BY THE ARCHITECT/ENGINEER OR THEIR REPRESENTATIVE. IF THE ARCHITECT/ENGINEER OR THEIR REPRESENTATIVE FINDS MATERIAL THAT DOES NOT CONFORM TO THESE SPECIFICATIONS OR THAT IS NOT PROPERLY INSTALLED OR FINISHED, CORRECT THE DEFICIENCIES IN A MANNER SATISFACTORY TO THE ARCHITECT/ENGINEER AT THE CONTRACTOR'S EXPENSE.

STARTUP, TESTING AND OWNER TRAINING

- ENGAGE A FACTORY AUTHORIZED REPRESENTATIVE TO CONDUCT AN INSPECTION OF THE INSTALLATION OF THEIR COMPANY'S EQUIPMENT PRIOR TO START-UP OF ANY EQUIPMENT. THE REPRESENTATIVE SHALL SUBMIT A REPORT IDENTIFYING ANY DEFICIENCIES TO THE ARCHITECT, ENGINEER AND CONSTRUCTION MANAGER. ANY DEFICIENCIES IDENTIFIED SHALL BE ADDRESSED PRIOR TO START-UP. START-UP SHALL BE CONDUCTED BY A FACTORY AUTHORIZED REPRESENTATIVE. STARTUP REPORTS SHALL BE SUBMITTED TO THE ARCHITECT AND ENGINEER ONCE COMPLETED.
- NEW AIR AND WATER SYSTEMS SHALL BE BALANCED IN THEIR ENTIRETY TO THE SATISFACTION OF THE ENGINEER IN ACCORDANCE WITH NEBB STANDARDS.
- THE MECHANICAL CONTRACTOR SHALL PROVIDE 4 HRS OF TRAINING TO THE OWNER TO ENSURE THE OWNER KNOWS HOW TO OPERATE THE SYSTEMS INSTALLED UNDER THE MECHANICAL CONTRACT. PROVIDE AN ADDITIONAL 4 HRS OF ADDITIONAL SERVICE THROUGH THE FIRST YEAR OF OPERATION TO ADDRESS QUESTIONS THAT MAY ARISE.

PROJECT CLOSEOUT

- THE MECHANICAL CONTRACTOR SHALL MAINTAIN AT THE PROJECT SITE, A "RECORD SET OF DRAWINGS" SHOWING FIELD CHANGES, AS-BUILT ELEVATIONS, UNUSUAL CONDITIONS ENCOUNTERED DURING CONSTRUCTION, AND SUCH OTHER DATA AS REQUIRED TO PROVIDE THE OWNER WITH AN ACCURATE "AS CONSTRUCTED" SET OF RECORD DRAWINGS. THE CONTRACTOR SHALL FURNISH THIS "RECORD SET" TO THE ENGINEER FOLLOWING THE FINAL INSPECTION OF THE PROJECT.
- THE MECHANICAL CONTRACTOR SHALL PROVIDE AN "OPERATION AND MAINTENANCE MANUAL" (O&M MANUAL) PRIOR TO THE COMMENCEMENT OF OWNER TRAINING. THE O&M MANUAL SHALL BE PROVIDED IN DIGITAL OR THREE PAPER COPIES (BOUND & LABELED) FORMAT AS REQUESTED BY THE ENGINEER OR OWNER. THE O&M MANUAL SHALL CONSIST OF A TITLE PAGE, TABLE OF CONTENTS, AND MANUAL CONTENTS. THE MANUAL CONTENTS SHALL CONSIST OF PRODUCT DATA INFORMATION, PRODUCT SERVICE/MAINTENANCE MANUAL, AND EXECUTED WARRANTY FOR EACH AND ALL EQUIPMENT AND PRODUCTS INSTALLED UNDER THE SCOPE OF THIS PROJECT.

DUCTWORK SCHEDULE

GENERAL NOTES:

- DUCTWORK SHALL BE CONSTRUCTED AND INSTALLED PER SMACNA GUIDELINES.
- RECTANGULAR DUCTWORK SHALL BE GALVANIZED SHEET METAL.
- RECTANGULAR DUCT ELBOWS SHALL HAVE TURNING VANES.
- ROUND DUCTWORK SHALL BE GALVANIZED SPIRAL SHEET METAL.
- PROVIDE SEISMIC BRACING OF DUCTWORK AS REQUIRED BY LOCAL CODES.
- SHEET METAL DUCTWORK GAGE SHALL BE SELECTED IN ACCORDANCE WITH SMACNA GUIDELINES.
- DUCTWORK SHALL BE SEALED IN ACCORDANCE WITH SMACNA AND THE CURRENT EDITION OF THE IECC.
- DUCT INSULATION MUST HAVE FLAME SPREAD LESS THAN 25 AND SMOKE-DEVELOPED INDEX OF NOT MORE THAN 50 WHEN TESTED IN ACCORDANCE WITH ASTM E84 OR UL 723.
- VALUES SCHEDULED BELOW ARE A MINIMUM AND SHALL BE SUPERSEDED BY MORE STRINGENT, CURRENTLY ADOPTED ENERGY OR MECHANICAL CODE REQUIREMENTS.

LOCATION	APPLICATION	INSULATION				
		TYPE	THICKNESS	R-VALUE	VAPOR BARRIER	FACTORY INSTALLED JACKET TYPE
INDOOR	EXHAUST (EA)	NONE	--	--	--	--

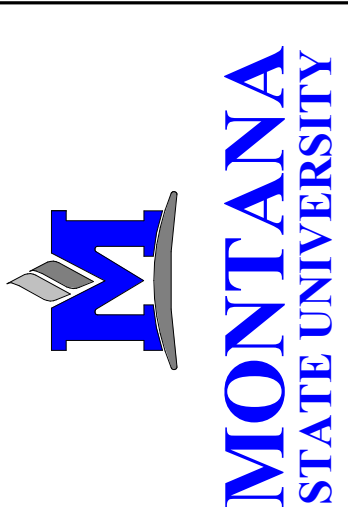

MSU-CPDC
MONTANA STATE UNIVERSITY
BOZEMAN, MONTANA
PHONE: 406.994.5413
FAX: 406.994.5665

BID SET
VISUAL COMMUNICATIONS
DARKROOMS 135 & 138 SINK
REPLACEMENT
MONTANA STATE UNIVERSITY



DRAWN BY: **LAG**

REVIEWED BY: **JRH**

REV.	DESCRIPTION	DATE

DRAWN BY:	LAG	
REVIEWED BY:	JRH	
REV.	DESCRIPTION	DATE

PPA#20-0006
A/E#23061.01
MMI#6161.011

SHEET TITLE
MECHANICAL DEMO
PLAN

SHEET
MD100

DATE
04-25-2024

MECHANICAL DEMO NOTES

- A. LOCATIONS AND DIMENSIONS OF EXISTING FACILITIES IDENTIFIED ON THIS DRAWING ARE APPROXIMATE AND REPRESENT THE BEST AVAILABLE INFORMATION BASED ON A COMBINATION OF FIELD INVESTIGATIONS AND VARIOUS DESIGN AND RECORD DRAWINGS AVAILABLE AT THE TIME OF THE DESIGN. FIELD VERIFY LOCATIONS AND DIMENSIONS PRIOR TO AND DURING PERFORMANCE OF THE WORK. PROVIDE DEMOLITION WORK NECESSARY TO COMPLETE THE SCOPE OUTLINED IN THE CONSTRUCTION DOCUMENTS.
- B. EXISTING MECHANICAL EQUIPMENT, DUCTWORK, AND PIPING SHOWN AS DARK AND DASHED SHALL BE DEMOLISHED. EXISTING MECHANICAL EQUIPMENT, DUCTWORK, AND PIPING SHOWN LIGHT SHALL REMAIN UNCHANGED.
- C. THE MECHANICAL CONTRACTOR SHALL COORDINATE SALVAGE OF REMOVED EQUIPMENT IN GOOD CONDITION WITH THE OWNER. THE MECHANICAL CONTRACTOR SHALL DISPOSE OF UNWANTED EQUIPMENT.
- D. COORDINATE UTILITY OUTAGES WITH THE GENERAL CONTRACTOR THROUGHOUT THE DURATION OF CONSTRUCTION. NOTIFICATION MUST BE GIVEN TO THE OWNER AT LEAST A WEEK PRIOR TO ANY PLANNED OUTAGES.
- E. COORDINATE WITH THE GENERAL CONTRACTOR TO PATCH AND REPAIR ROOF, WALL, CEILING, OR FLOOR PENETRATIONS ASSOCIATED WITH THE DEMOLITION OF THE EXISTING MECHANICAL SYSTEMS.

KEY NOTES:

- 1. DEMO EXISTING DUCTWORK SERVING TABLE BACK TO MAIN.
- 2. COORDINATE DUCT DEMOLITION WITH NEW WORK.
- 3. CAP OPENING AND SEAL TIGHT.

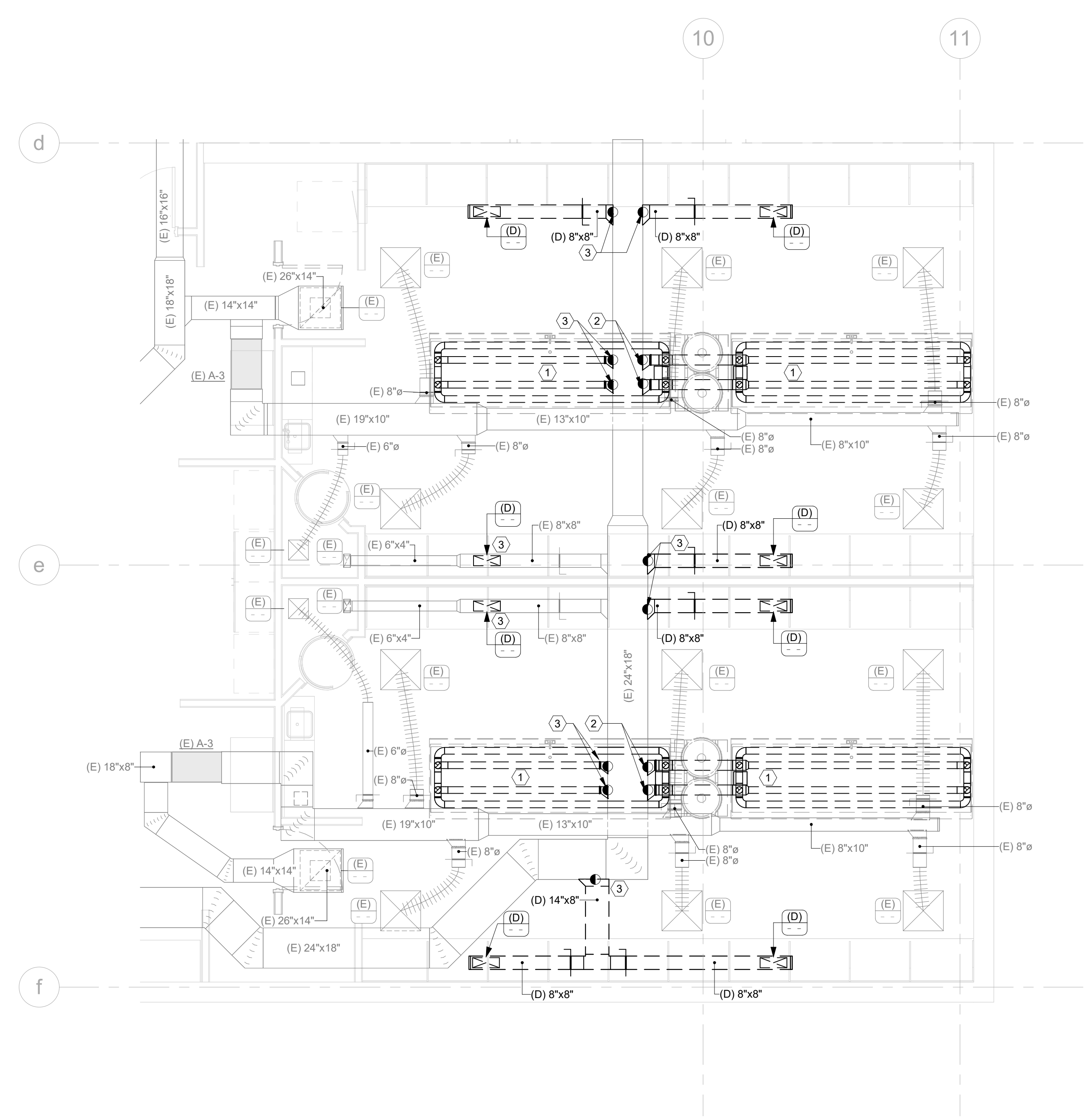

1 MECHANICAL DEMO FLOOR PLAN
1/4" = 1'-0"

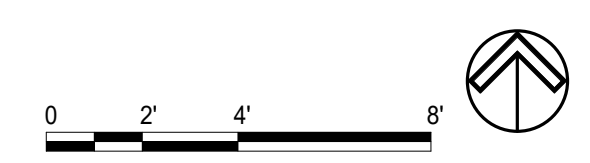

ABBREVIATIONS

ACC	AIR COOLED CONDENSER	ID	INSIDE DIAMETER
ACU	AIR CONDITIONING UNIT	IFB	INTEGRAL FACE & BYPASS
AD	ACCESS DOOR	IGV	INLET GUIDE VANES
ADJ	ADJUSTABLE	IPS	IRON PIPE SIZE
AF	AIR FOIL	IU	INDUCTION UNIT
AFF	ABOVE FINISHED FLOOR	KW	KILOWATTS
AFG	ABOVE FINISHED GRADE	KWH	KILOWATT HOUR
AFR	ABOVE FINISHED ROOF	LAT	LEAVING AIR TEMPERATURE (°F)
AFS	AIR FLOW STATION	LF	LINEAR FEET
AHU	AIR HANDLING UNIT	LWT	LEAVING WATER TEMPERATURE (°F)
AP	ACCESS PANEL	M	MOTOR OPERATED
ATC	AUTOMATIC TEMPERATURE CONTROL	MAU	MAKEUP AIR UNIT
ATM	ATMOSPHERE	MB	MIXING BOX
AWG	AMERICAN WIRE GAUGE	MBH	1000 BTU/HR
B	BOILER	MC	MECHANICAL CONTRACTOR
BB	BASEBOARD	MFR	MANUFACTURER
BC	BACKWARD CURVED	MS	MINI-SPLIT
BD	BACKDRAFT DAMPER	NC	NOISE CRITERIA
BF	BOILER FEED	NC	NORMALLY CLOSED
BHP	BRAKE HORSEPOWER	NIC	NOT IN CONTRACT
BI	BACKWARD INCLINED	NO	NORMALLY OPEN
BMS	BUILDING MANAGEMENT SYSTEM	NPS	NOMINAL PIPE SIZE
BOD	BOTTOM OF DUCT	OA	OUTSIDE AIR
BOJ	BOTTOM OF JOIST	OAD	OUTSIDE AIR DAMPER
BOS	BOTTOM OF STEEL	OBD	OPPOSED BLADE DAMPER
BTU	BRITISH THERMAL UNIT	P	PUMP
C	COMMON	PC	PLUMBING CONTRACTOR
CAV	CONSTANT AIR VOLUME	PD	PRESSURE DROP
CC	COOLING COIL	PH	PHASE
CCW	COUNTER CLOCKWISE	PHC	PREHEAT COIL
CFM	CUBIC FEET PER MINUTE	PPM	PART PER MILLION
CH	CHILLER	PROP	PROPELLER
C&I	CONTROLS & INSTRUMENTATION	PRV	PRESSURE REDUCING VALVE
CLG	CEILING	PSIA	PSI, ABSOLUTE
CMU	CONCRETE MASONRY UNIT	PSIG	PSI, GAUGE
CND	CONDENSATE	QTY	QUANTITY
CONT	CONTINUATION	R	REGISTER
CORR	CORRIDOR	RA	RETURN AIR
COTG	CLEANOUT TO GRADE	RD	RADIAL DAMPER
CT	COOLING TOWER	RF	RETURN/RELIEF AIR FAN
CU	CONDENSING UNIT	RH	RELATIVE HUMIDITY
CH	CABINET HEATER	RHC	REHEAT COIL
CV	CONTROL VALVE	SA	SUPPLY AIR
CVS	CONTROL VALVE STATION	SAF	SUPPLY AIR FAN
CW	CLOCKWISE	SC	SENSIBLE COOLER
dB	DECIBEL	SCFM	CFM, STANDARD CONDITIONS
DB	DRY BULB TEMPERATURE (°F)	SD	SMOKE DETECTOR
DDC	DIRECT DIGITAL CONTROL	SEER	SEASONAL ENERGY EFFICIENCY RATIO
DDC	DUCT HEATER	SENS	SENSIBLE
DP	DEW POINT TEMPERATURE (°F)	SP	STATIC PRESSURE
DX	DIRECT EXPANSION	SPS	STATIC PRESSURE SENSOR
E	EXHAUST	SS	STAINLESS STEEL
EA	EXHAUST AIR	T	THERMOSTAT
EAT	ENTERING AIR TEMPERATURE (°F)	TA	TRANSFER AIR
EC	ELECTRICAL CONTRACTOR	TCC	TEMPERATURE CONTROL CONTRACTOR
ECO	EXTERIOR CLEANOUT	TCP	TEMPERATURE CONTROL PANEL
EDR	EQUIVALENT DIRECT RADIATION	TG	TRANSFER GRILL
EER	ENERGY EFFICIENCY RATIO	TOD	TOP OF DUCT
EF	EXHAUST FAN	TOP	TOP OF PIPE
EFF	EFFICIENCY	TOS	TOP OF STEEL
ELEV	ELEVATION	TSP	TOTAL STATIC PRESSURE
ERV	ENERGY RECOVERY VENTILATOR	TW	TEMPERED WATER
ESP	EXTERNAL STATIC PRESSURE	TYP	TYPICAL
ET	EXPANSION TANK	UH	UNIT HEATER
EWT	ENTERING WATER TEMPERATURE (°F)	UNC	UNDERCUT
F&T	FLOAT & THERMOSTATIC	UV	UNIT VENTILATOR
FA	FACE AREA	VA	VOLT-AMPERE
FC	FAN COIL	VAV	VARIABLE AIR VOLUME
FP	FIRE PROTECTION	VD	VOLUME DAMPER
FPM	FEET PER MINUTE	VEL	VELOCITY
FT	FEET	VFD	VARIABLE FREQUENCY DRIVE
GA	GAUGE OR GAGE	VRF	VARIABLE REFRIGERANT FLOW
GC	GENERAL CONTRACTOR	VTR	VENT THROUGH ROOF
GEN	GENERATOR	WB	WET BULB TEMPERATURE (°F)
GH	GRAVITY HOOD	WC	WATER COLUMN
GPD	GALLONS PER DAY	WG	WATER GAUGE
GPH	GALLONS PER HOUR	WSHP	WATER SOURCE HEAT PUMP
GPM	GALLONS PER MINUTE	ΔT	TEMPERATURE DIFFERENCE (°F)
H	HUMIDIFIER		
HC	HEATING COIL		
HG	MERCURY		
HP	HORSEPOWER		
HR	HOUR		
HX	HEAT EXCHANGER		

PLUMBING LEGEND

ANNOTATION SYMBOLS

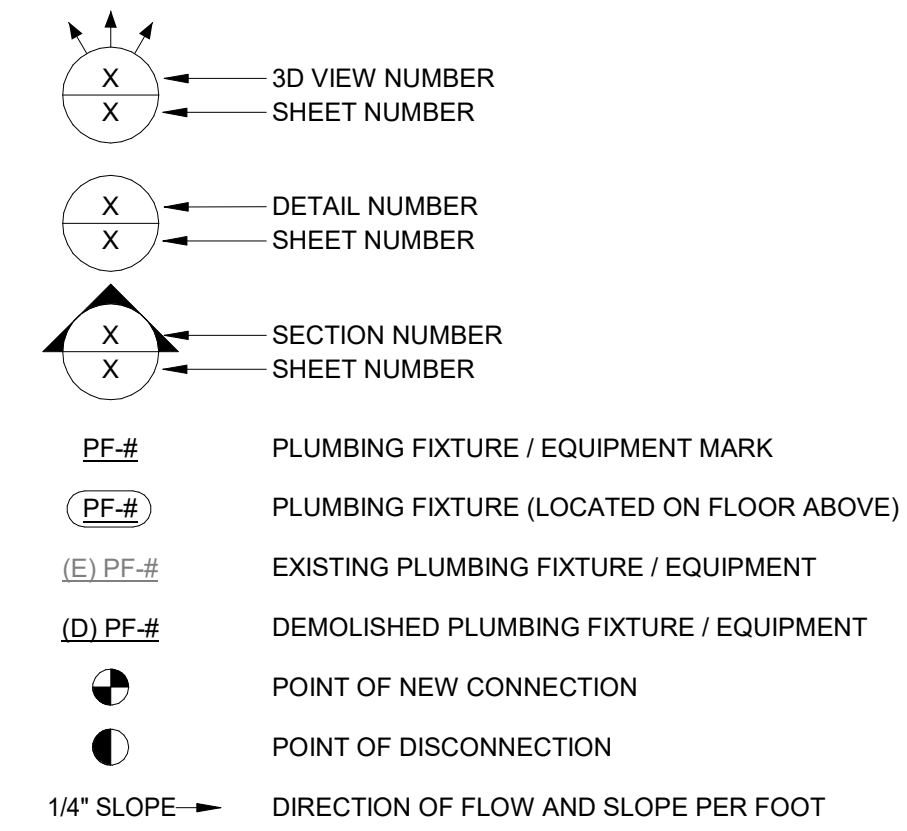

GENERAL

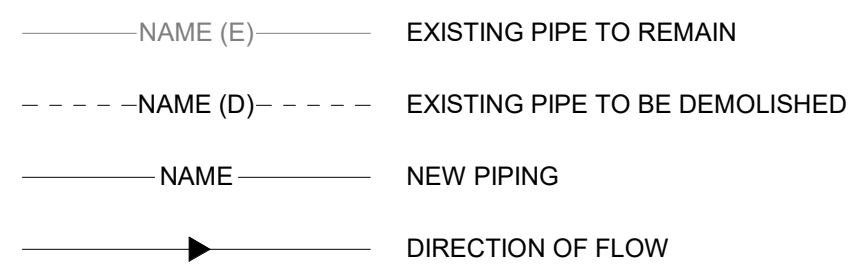

PLUMBING

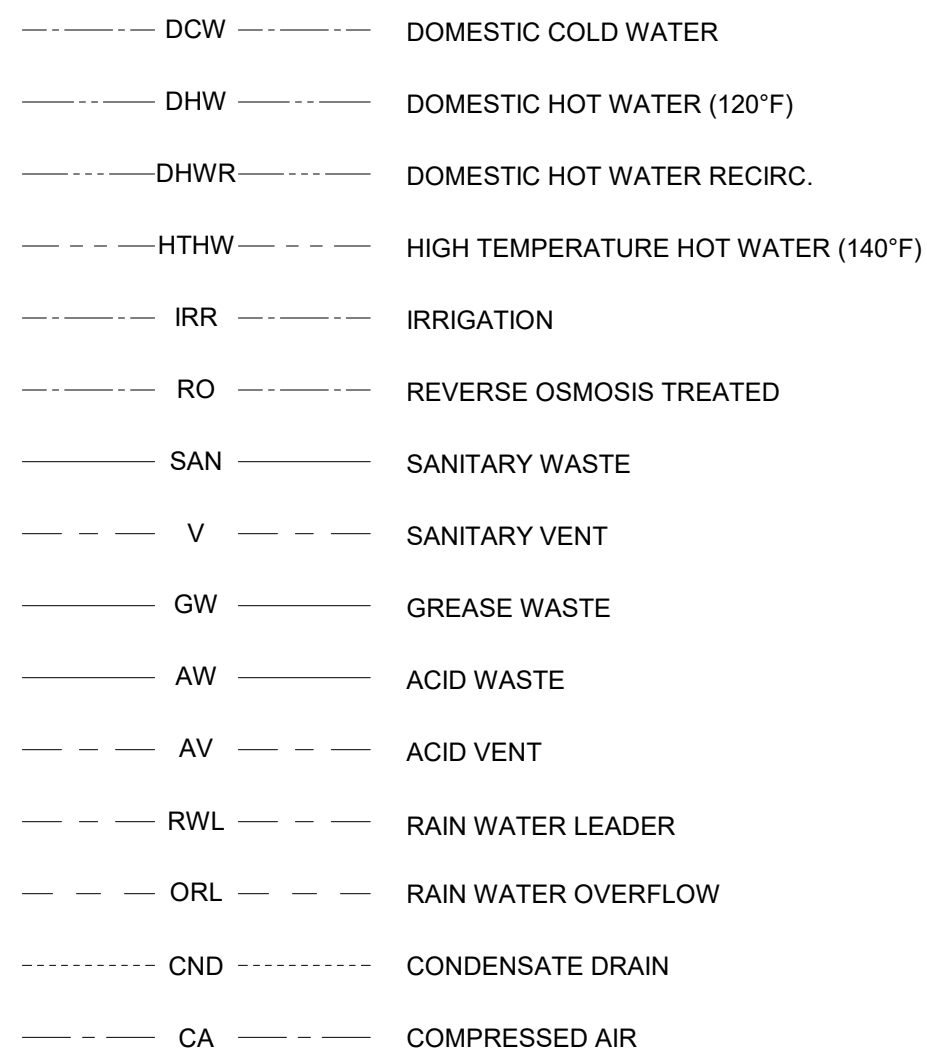

PIPE FITTINGS

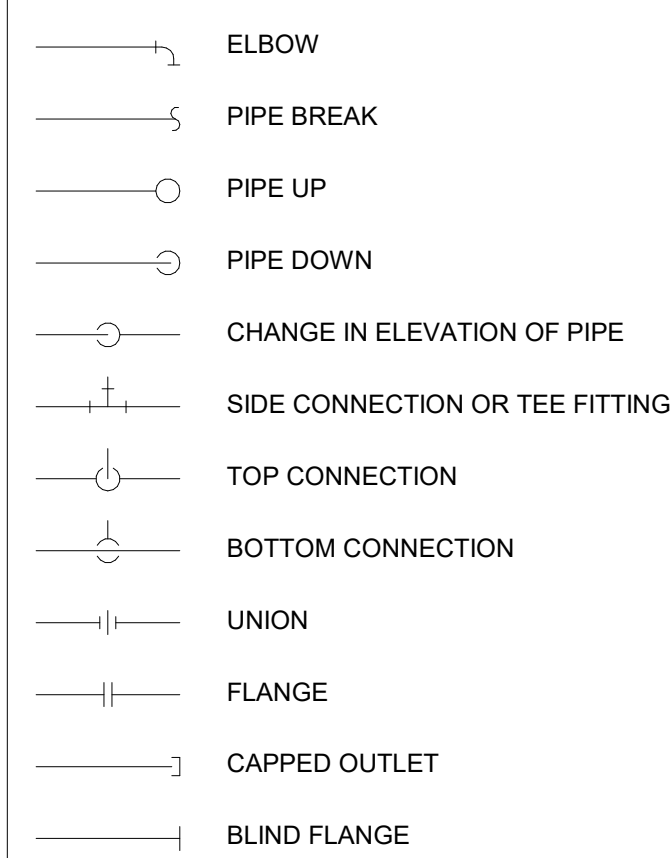

VALVES

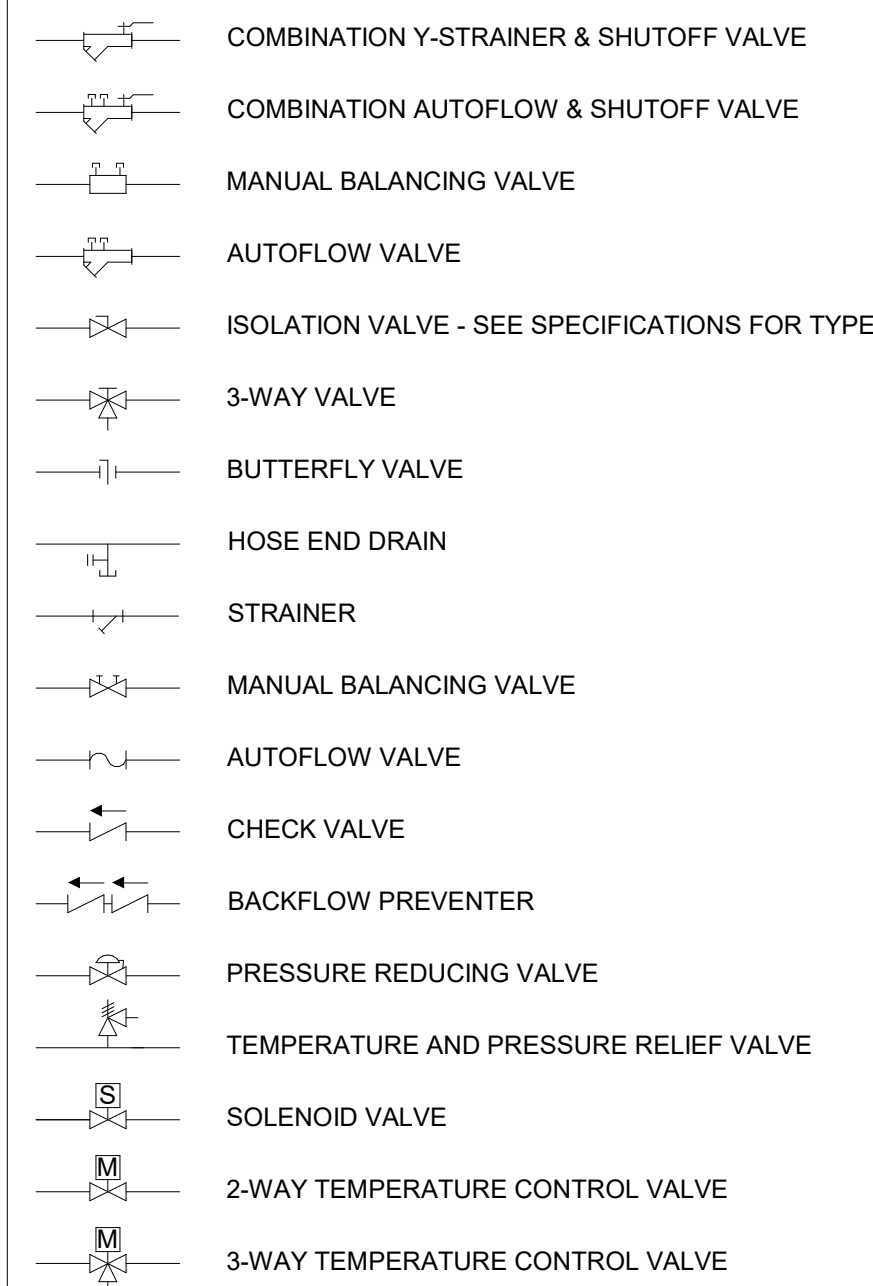

PIPING SPECIALTIES

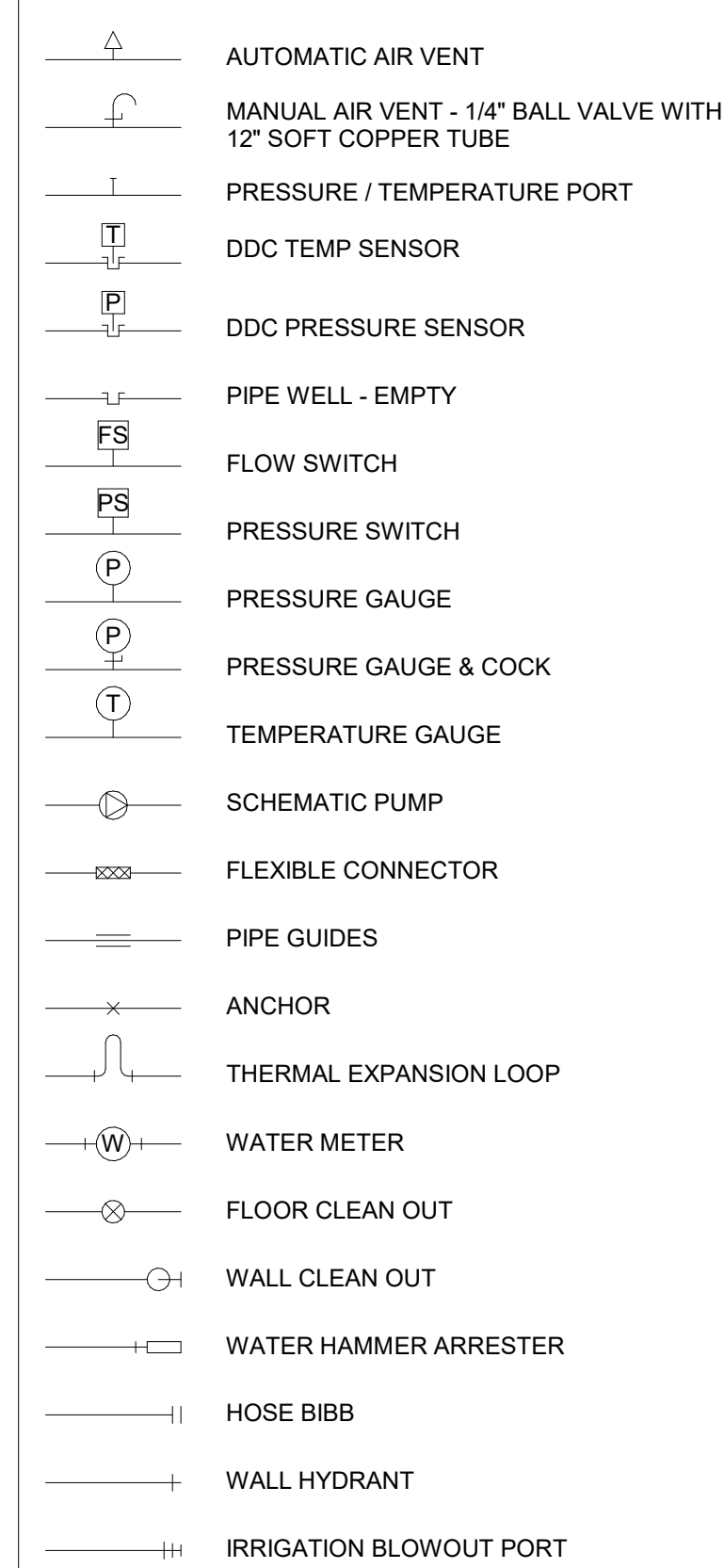

NOTE: THIS IS A STANDARD LEGEND. NOT ALL PIPE TYPES AND SYMBOLS ARE NECESSARILY UTILIZED IN THE DRAWINGS.

PLUMBING GENERAL NOTES

- INSTALLATION:**
- NEW PIPING AND EQUIPMENT TO BE INSTALLED IN ACCORDANCE WITH THE CURRENTLY ADOPTED UNIFORM PLUMBING AND INTERNATIONAL BUILDING CODES.
 - EQUIPMENT SHALL BE INSTALLED LEVEL, PLUMB, AND FIRMLY ANCHORED IN LOCATIONS INDICATED. OBSERVE MANUFACTURER'S INSTALLATION INSTRUCTIONS AND RECOGNIZED INDUSTRY PRACTICES TO ENSURE THAT PRODUCTS SERVE THEIR INTENDED FUNCTION.
 - DRAWINGS ARE DIAGRAMMATIC IN NATURE. THE PURPOSE OF THESE PLANS IS TO INDICATE THE INTENDED SIZES, APPROXIMATE LOCATION AND ROUTING OF MAJOR COMPONENTS. ACTUAL CONDITIONS AND LOCATIONS SHALL BE FIELD VERIFIED AND ADJUSTED IF NECESSARY.
 - PROVIDE AND INSTALL SEISMIC BRACING FOR EQUIPMENT AND PIPING PER THE REQUIREMENTS OF THE CURRENTLY ADOPTED INTERNATIONAL BUILDING CODE.
 - ELEMENTS PENETRATING BUILDING COMPONENTS (ROOF ASSEMBLIES, WALL ASSEMBLIES, ETC.) SHALL BE SEALED WEATHER AND WATER TIGHT. COORDINATE PENETRATIONS WITH GENERAL CONTRACTOR TO PATCH TO THE SATISFACTION OF THE ARCHITECT OR ENGINEER.
 - MATERIAL THAT IS IN CONTACT WITH POTABLE DOMESTIC WATER SHALL BE NSF CERTIFIED LEAD FREE.

- COORDINATION:**
- IT SHALL BE THE RESPONSIBILITY OF THE PLUMBING CONTRACTOR TO FIELD COORDINATE THE LOCATION OF EQUIPMENT AND ROUTING OF PIPING WITH OTHER TRADES.
 - IT SHALL BE THE RESPONSIBILITY OF THE PLUMBING CONTRACTOR TO REVIEW THE DRAWINGS OF OTHER DISCIPLINES AND PROVIDE LABOR AND MATERIALS REQUIRED FOR A COMPLETE INSTALLATION.

- ELECTRICAL COORDINATION:**
- SEE THE MEP COORDINATION SCHEDULE FOR ELECTRICAL INFORMATION. COORDINATE WITH OTHER TRADES TO ENSURE THAT ELECTRICAL DISCONNECTS, MOTOR STARTERS, VARIABLE FREQUENCY DRIVES, CONTROLS, AND ELECTRICAL ACCESSORIES ARE FURNISHED AND/OR INSTALLED BY THE APPROPRIATE TRADE.

- SITE ELEVATION:**
- EQUIPMENT SHALL BE SELECTED FOR THE PROJECT ELEVATION OF 4,900'.

PLUMBING SHEET INDEX

NUMBER	SHEET NAME
P001	PLUMBING LEGEND & NOTES
P002	PLUMBING SPECIFICATIONS
PD100	PLUMBING UNDERSLAB DEMO PLAN
PD101	PLUMBING DEMO PLAN
P100	PLUMBING UNDERSLAB PLAN
P101	PLUMBING FLOOR PLAN

BID SET

VISUAL COMMUNICATIONS
DARKROOMS 135 & 138 SINK
REPLACEMENT
MONTANA STATE UNIVERSITY



DRAWN BY: **LAG**

REVIEWED BY: **JRH**

REV.	DESCRIPTION	DATE

PPA#20-0006

A/E#23061.01

MMI#6161.011

SHEET TITLE
PLUMBING LEGEND & NOTES

SHEET
P001

DATE
04-25-2024

PLUMBING SPECIFICATIONS

GENERAL

- THE PLUMBING CONTRACTOR SHALL INCLUDE ALL ITEMS, ARTICLES, MATERIALS, OPERATIONS AND METHODS LISTED, MENTIONED, OR SCHEDULED IN THESE SPECIFICATIONS AND THE ACCOMPANYING DRAWINGS. ALL MATERIAL, EQUIPMENT, AND LABOR SHALL BE FURNISHED TOGETHER WITH ALL INCIDENTAL ITEMS REQUIRED BY GOOD PRACTICE TO PROVIDE THE COMPLETE SYSTEMS DESCRIBED.
- EXAMINE AND REFER TO ALL ARCHITECTURAL, CIVIL, STRUCTURAL, ELECTRICAL, UTILITY, LANDSCAPE AND PLUMBING DRAWINGS AND SPECIFICATIONS FOR CONSTRUCTION CONDITIONS WHICH MAY AFFECT THE PLUMBING WORK. INSPECT THE BUILDING SITE AND EXISTING FACILITIES FOR VERIFICATION OF PRESENT CONDITIONS. MAKE PROPER PROVISIONS FOR THESE CONDITIONS IN PERFORMANCE OF THE WORK AND COST THEREOF.
- ALL WORK ON THE PROJECT SHALL CONFORM TO ALL ADOPTED CITY, STATE, AND NATIONAL CODES & REGULATIONS. SUCH CODES & REGULATIONS INCLUDE, BUT ARE NOT LIMITED TO, THE IBC, IMC, IECC, UPC, NFPA, NEC, SERVICING UTILITY COMPANIES AND THE AUTHORITY HAVING JURISDICTION.
- THE PLUMBING AND ELECTRICAL CONTRACTORS SHALL BE RESPONSIBLE FOR AND PAY FOR ALL FEES AND PERMITS REQUIRED FOR WORK UNDER THEIR CONTRACT AND UNDER THEIR SUPERVISION BY SUBCONTRACT.
- ALL USAGE CONTRACTS BETWEEN THE OWNER AND THE SERVING UTILITIES COMPANY, SUCH AS MEMBERSHIP AND USAGE CHARGES OR FEES, ETC., FOR THE PURPOSE OF OBTAINING THE SERVICES FOR THE UTILITY COMPANY SHALL BE APPLIED FOR AND PAID FOR BY THE OWNER.

RESPONSIBILITY

- THE PLUMBING CONTRACTOR SHALL BE RESPONSIBLE FOR THE INSTALLATION OF A SATISFACTORY AND COMPLETE SYSTEM IN ACCORDANCE WITH THE INTENT OF THE DRAWING AND SPECIFICATIONS. PROVIDE, AT NO EXTRA COST, ALL INCIDENTAL ITEMS, MATERIALS, ACCESSORIES AND LABOR REQUIRED FOR COMPLETION OF THE WORK EVEN THOUGH THEY ARE NOT SPECIFICALLY MENTIONED OR INDICATED ON THE DRAWINGS OR IN THE SPECIFICATIONS.
- THE DRAWINGS DO NOT ATTEMPT TO SHOW COMPLETE DETAILS OF THE BUILDING CONSTRUCTION WHICH AFFECT THE PLUMBING INSTALLATION; AND REFERENCE IS THEREFORE REQUIRED TO THE ARCHITECTURAL, CIVIL, STRUCTURAL, LANDSCAPE AND ELECTRICAL DRAWINGS AND SPECIFICATIONS AND TO SHOP DRAWINGS OF ALL TRADES FOR ADDITIONAL DETAILS WHICH AFFECT THE INSTALLATION OF THE WORK COVERED UNDER THIS DIVISION OF THE CONTRACT.
- LOCATION OF PLUMBING SYSTEM COMPONENTS SHALL BE CHECKED FOR CONFLICTS WITH OPENINGS, STRUCTURAL MEMBERS AND COMPONENTS OF OTHER SYSTEMS HAVING FIXED LOCATIONS. IN THE EVENT OF ANY CONFLICTS, THE ARCHITECT/ENGINEER SHALL BE CONSULTED AND THEIR DECISION SHALL GOVERN. NECESSARY CHANGES SHALL BE MADE AT THE CONTRACTOR'S EXPENSE.
- DO NOT INSTALL EQUIPMENT UNTIL COMPLETE SHOP DRAWINGS OF SUCH EQUIPMENT HAVE BEEN APPROVED BY THE ARCHITECT/ENGINEER. ANY WORK INSTALLED BY THE CONTRACTOR, PRIOR TO APPROVAL OF SHOP DRAWINGS, WILL BE AT THE CONTRACTOR'S RISK.
- ALL MODIFICATIONS AND CHANGES REQUIRED DUE TO INSTALLATION OF EQUIPMENT OTHER THAN THE EQUIPMENT SCHEDULED AND SPECIFIED SHALL BE MADE AT THE CONTRACTOR'S EXPENSE. THIS INCLUDES WORK BY OTHER TRADES. IF THE INSTALLATION OF EQUIPMENT OTHER THAN THE SCHEDULED AND SPECIFIED EQUIPMENT REQUIRES MODIFICATIONS TO STRUCTURE, ELECTRICAL SYSTEMS, PLUMBING SYSTEMS, FIRE PROTECTION OR FIRE ALARM SYSTEMS, ANY AND ALL CHANGES SHALL BE MADE AT THE PLUMBING CONTRACTORS EXPENSE.
- ALL WORK TO BE PERFORMED SHALL FIRST BE SCHEDULED AND SUBMITTED TO THE OWNER'S REPRESENTATIVE FOR ACCEPTANCE.
- THE CONTRACTOR SHALL BE CAREFUL NOT TO BLOCK ANY PATHS OF EGRESS WHILE PERFORMING THE WORK SPECIFIED.
- THE CONTRACTOR SHALL BE RESPONSIBLE FOR CLEANUP OF ALL MATERIALS RESULTING FROM HIS/HER WORK. CLEANUP SHALL BE PERFORMED TO THE LEVEL OF ACCEPTANCE OF THE OWNER'S REPRESENTATIVE & THE ENGINEER.
- THE CONTRACTOR SHALL GUARANTEE THAT ALL WORK EXECUTED UNDER THEIR CONTRACT SHALL BE FREE OF DEFECTS OF MATERIALS AND WORKMANSHIP FOR A PERIOD OF ONE (1) YEAR FROM THE DATE OF SUBSTANTIAL COMPLETION.

INTENT OF DRAWINGS

- THE DRAWINGS ARE PARTLY DIAGRAMMATIC AND DO NOT NECESSARILY SHOW EXACT LOCATION OF PIPING AND DUCTWORK UNLESS SPECIFICALLY DIMENSIONED. RISER AND OTHER DIAGRAMS ARE SCHEMATIC AND DO NOT NECESSARILY SHOW THE PHYSICAL ARRANGEMENT OF THE EQUIPMENT. THEY SHALL NOT BE USED FOR OBTAINING LINEAL RUNS OF PIPING OR DUCTWORK, NOR SHALL THEY BE USED FOR SHOP DRAWINGS FOR PIPING AND DUCTWORK FABRICATION OR ORDERING. DISCREPANCIES SHOWN ON DIFFERENT PLANS, OR BETWEEN PLANS AND ACTUAL FIELD CONDITIONS SHALL BE BROUGHT TO THE ATTENTION OF THE ARCHITECT/ENGINEER FOR RESOLUTION.

MATERIALS AND EQUIPMENT

- MANUFACTURER'S TRADE NAMES AND CATALOG NUMBERS ARE LISTED TO INDICATE THE QUALITY OF EQUIPMENT OR MATERIALS DESIRED FOR INSTALLATION. ALTERNATIVE EQUIPMENT OR MATERIALS MAY BE SUBMITTED FOR PRIOR APPROVAL BEFORE BIDDING. NO SUBSTITUTIONS WILL BE ALLOWED AFTER BIDDING.
- WRITTEN PRIOR APPROVAL FOR SUBSTITUTIONS MUST BE SUBMITTED TO AND RECEIVED BY THE ARCHITECT/ENGINEER SEVEN (7) DAYS PRIOR TO BID OPENING. REQUESTS FOR SUBSTITUTION ARE TO BE SUBMITTED SUFFICIENTLY AHEAD OF THE DEADLINE TO GIVE AMPLE TIME FOR EXAMINATION. PRIOR APPROVAL REQUEST FOR SUBSTITUTION MUST INDICATE THE SPECIFIC ITEM OR ITEMS TO BE FURNISHED IN LIEU OF THOSE SCHEDULED, TOGETHER WITH COMPLETE TECHNICAL AND COMPARATIVE DATA ON SCHEDULED ITEMS AND ITEMS PROPOSED FOR SUBSTITUTION.
- HIGH ALTITUDE OPERATION: CAPACITY OF ALL EQUIPMENT IS TO BE SIZED AND MANUFACTURED TO PERFORM AT THE ELEVATION OF THE PROJECT SITE. IF NOT SPECIFICALLY INDICATED IN THE EQUIPMENT SCHEDULE OR IN THE SPECIFICATIONS PROVIDE ALL REQUIRED ACCESSORIES AND EQUIPMENT FOR PROPER OPERATION AT ELEVATION OF THE PROJECT SITE.
- STORE MATERIALS AND EQUIPMENT INDOORS AT THE JOB SITE OR, IF THIS IS NOT POSSIBLE, STORE ON RAISED PLATFORMS AND PROTECT FROM THE WEATHER BY MEANS OF WATERPROOF COVERS. COVERINGS SHALL PERMIT CIRCULATION OF AIR AROUND THE MATERIALS TO PREVENT CONDENSATION OF MOISTURE. SCREEN OR CAP OPENINGS IN EQUIPMENT TO PREVENT THE ENTRY OF VERMIN.
- ALL NEW PIPING SHALL BE IDENTIFIED WITH SETON SET MARK PIPE MARKERS, LETTERED TO MATCH EXISTING - IF APPLICABLE - AND MARKED AT A MAXIMUM OF EVERY 25 FT. ALL NEW VALVES SHALL BE IDENTIFIED WITH BRASS OR ALUMINUM VALVE TAGS.

MATERIALS AND EQUIPMENT (CONT.)

- SEE THE PLUMBING PIPING SCHEDULE ON THE DRAWINGS FOR MATERIAL AND INSULATION REQUIREMENTS.
- COORDINATE THE INSTALLATION OF GRILLES, REGISTERS AND DIFFUSERS WITH THE ARCHITECTURAL REFLECTED CEILING PLANS AND THE ELECTRICAL LIGHTING PLANS.
- VERIFY THE LOCATION OF THERMOSTATS AND SENSORS WITH THE ARCHITECT AND ENGINEER PRIOR TO INSTALLATION. INSTALL THERMOSTATS 48" ABOVE FINISHED FLOOR PER ADA REQUIREMENTS.
- PROVIDE AND INSTALL SEISMIC BRACING FOR ALL EQUIPMENT, DUCTWORK AND PIPING PER THE REQUIREMENTS OF THE INTERNATIONAL BUILDING CODE.
- FLEXIBLE DUCTWORK BETWEEN BRANCH DUCTS AND GRILLES, REGISTERS OR DIFFUSERS SHALL BE LIMITED TO 5FT.
- INSTALL ACCESSIBLE PLUMBING FIXTURES IN COMPLIANCE WITH ADA REQUIREMENTS. INSULATE ALL EXPOSED PIPING BELOW ADA ACCESSIBLE FIXTURES.
- INSTALL FLOOR DRAIN STRAINERS AND CLEANOUT COVERS FLUSH AND LEVEL WITH FINISHED FLOOR.
- THE PLUMBING CONTRACTOR SHALL BE RESPONSIBLE FOR FIRE-CAULKING ALL FIRE-RATED AND SMOKE-RATED WALL PENETRATIONS OF PIPING, DUCTWORK, ETC.
- PROVIDE ACCESS DOORS TO ALLOW SERVICE AND INSPECTION OF EQUIPMENT, VALVES, DAMPERS AND DEVICES INSTALLED ABOVE NON-REMOVABLE CEILINGS.

SHOP DRAWINGS AND SUBMITTALS

- WITHIN 30 DAYS OF AWARDING OF THE CONTRACT, THE PLUMBING CONTRACTOR SHALL SUBMIT SHOP DRAWINGS AND/OR SUBMITTALS FOR ALL SCHEDULED EQUIPMENT AND MATERIALS INCLUDED IN THE CONSTRUCTION DOCUMENTS.
- ALL SHOP DRAWINGS AND SUBMITTALS SHALL BE IN THE FORM OF ELECTRONICALLY TRANSMITTED PDFS. SHOP DRAWINGS AND SUBMITTALS SHALL INCLUDE SHOP DRAWINGS AND LITERATURE SHOWING ITEMS TO BE USED, SIZE, DIMENSIONS, CAPACITY, ROUGH-IN, AND ANY OTHER INFORMATION NECESSARY FOR A COMPLETE REVIEW. MANUFACTURER'S LITERATURE SHOWING MORE THAN ONE ITEM SHALL BE CLEARLY MARKED AS TO WHICH ITEM IS BEING FURNISHED OR IT WILL BE REJECTED AND RETURNED WITHOUT REVIEW.
- EACH SUBMITTED ITEM MUST BE CLEARLY MARKED WITH THE PROJECT NAME, DATE, BRANCH OF WORK, SUBMITTING PARTY, REVISION NUMBER, AND ASSOCIATED SCHEDULE. SUBMITTALS NOT IDENTIFIED AS DESCRIBED ABOVE WILL BE REJECTED AND RETURNED WITHOUT REVIEW.
- PRIOR TO THEIR SUBMISSION, EACH SUBMITTAL SHALL BE THOROUGHLY CHECKED BY THE CONTRACTOR FOR COMPLIANCE WITH THE CONTRACT DOCUMENT REQUIREMENTS. EACH SUBMITTAL SHALL THEN BEAR A STAMP EVIDENCING SUCH CHECKING AND SHALL SHOW CORRECTIONS MADE. IF ANY SUBMITTALS REQUIRING EXTENSIVE CORRECTIONS SHALL BE REVISED BEFORE SUBMISSION TO THE ENGINEER. EACH SUBMITTAL NOT STAMPED AND SIGNED BY THE CONTRACTOR EVIDENCING SUCH CHECKING WILL BE REJECTED AND RETURNED WITHOUT REVIEW.
- REVIEW OF THE SHOP DRAWINGS AND LITERATURE BY THE ENGINEER SHALL NOT RELIEVE THE CONTRACTOR FOR RESPONSIBILITY FOR DEVIATIONS FROM THE DRAWINGS OR SPECIFICATIONS. NOR SHALL IT RELIEVE THE CONTRACTOR FROM RESPONSIBILITY FOR ERRORS IN THE SHOP DRAWINGS OR LITERATURE. IT IS THE RESPONSIBILITY OF THE CONTRACTOR TO PROVIDE MATERIALS AND EQUIPMENT WHICH MEET THE SPECIFICATIONS AND JOB REQUIREMENTS.

REVIEW & SITE INSPECTIONS

- ALL WORK AND MATERIAL IS SUBJECT TO REVIEW AT ANY TIME BY THE ARCHITECT/ENGINEER OR THEIR REPRESENTATIVE. IF THE ARCHITECT/ENGINEER OR THEIR REPRESENTATIVE FINDS MATERIAL THAT DOES NOT CONFORM TO THESE SPECIFICATIONS OR THAT IS NOT PROPERLY INSTALLED OR FINISHED, CORRECT THE DEFICIENCIES IN A MANNER SATISFACTORY TO THE ARCHITECT/ENGINEER AT THE CONTRACTOR'S EXPENSE.

STARTUP, TESTING AND OWNER TRAINING

- ENGAGE A FACTORY AUTHORIZED REPRESENTATIVE TO CONDUCT AN INSPECTION OF THE INSTALLATION OF THEIR COMPANY'S EQUIPMENT PRIOR TO START-UP OF ANY EQUIPMENT. THE REPRESENTATIVE SHALL SUBMIT A REPORT IDENTIFYING ANY DEFICIENCIES TO THE ARCHITECT, ENGINEER AND CONSTRUCTION MANAGER. ANY DEFICIENCIES IDENTIFIED SHALL BE ADDRESSED PRIOR TO START-UP. START-UP SHALL BE CONDUCTED BY A FACTORY AUTHORIZED REPRESENTATIVE. STARTUP REPORTS SHALL BE SUBMITTED TO THE ARCHITECT AND ENGINEER ONCE COMPLETED.
- NEW AIR AND WATER SYSTEMS SHALL BE BALANCED IN THEIR ENTIRETY TO THE SATISFACTION OF THE ENGINEER IN ACCORDANCE WITH NEBB STANDARDS.
- THE PLUMBING CONTRACTOR SHALL PROVIDE 4 HRS OF TRAINING TO THE OWNER TO ENSURE THE OWNER KNOWS HOW TO OPERATE THE SYSTEMS INSTALLED UNDER THE PLUMBING CONTRACT. PROVIDE AN ADDITIONAL 4 HRS OF ADDITIONAL SERVICE THROUGH THE FIRST YEAR OF OPERATION TO ADDRESS QUESTIONS THAT MAY ARISE.

PROJECT CLOSEOUT

- THE PLUMBING CONTRACTOR SHALL MAINTAIN AT THE PROJECT SITE, A "RECORD SET OF DRAWINGS" SHOWING FIELD CHANGES, AS-BUILT ELEVATIONS, UNUSUAL CONDITIONS ENCOUNTERED DURING CONSTRUCTION, AND SUCH OTHER DATA AS REQUIRED TO PROVIDE THE OWNER WITH AN ACCURATE "AS CONSTRUCTED" SET OF RECORD DRAWINGS. THE CONTRACTOR SHALL FURNISH THIS "RECORD SET" TO THE ENGINEER FOLLOWING THE FINAL INSPECTION OF THE PROJECT.
- THE PLUMBING CONTRACTOR SHALL PROVIDE AN "OPERATION AND MAINTENANCE MANUAL" (O&M MANUAL) PRIOR TO THE COMMENCEMENT OF OWNER TRAINING. THE O&M MANUAL SHALL BE PROVIDED IN DIGITAL OR THREE PAPER COPIES (BOUND & LABELED) FORMAT AS REQUESTED BY THE ENGINEER OR OWNER. THE O&M MANUAL SHALL CONSIST OF A TITLE PAGE, TABLE OF CONTENTS, AND MANUAL CONTENTS. THE MANUAL CONTENTS SHALL CONSIST OF PRODUCT DATA INFORMATION, PRODUCT SERVICE/MAINTENANCE MANUAL, AND EXECUTED WARRANTY FOR EACH AND ALL EQUIPMENT AND PRODUCTS INSTALLED UNDER THE SCOPE OF THIS PROJECT.

PLUMBING FIXTURE SCHEDULE

MARK	MFG	MODEL #	DESCRIPTION	MATERIAL & FINISH	TRIM	ROUGH-IN SIZE					REMARKS
						RL/ORL	WASTE	VENT	COLD	HOT	
TD-1	WATTS	DEAD LEVEL P	PRE-SLOPED TRENCH DRAIN	POLYPROPYLENE BODY / DUCTILE IRON GRATE	--	--	2"	2"	--	--	VERIFY NUMBER OF SECTIONS AND SLOPE PRIOR TO ORDERING.
TV-1	ARMSTRONG	THE BRAIND DRV25	DIGITAL MIXING VALVE	STAINLESS STEEL VALVE	--	--	--	--	3/4"	3/4"	COORDINATE POWER REQUIREMENTS FOR TEMPERING VALVE WITH ELECTRICAL CONTRACTOR.

NOTES: PROVIDE FIXTURES WITH APPROPRIATE P-TRAPS

PLUMBING PIPE SCHEDULE

- NOTE:
- INSULATION THICKNESS IS BASED ON A CONDUCTIVITY NOT EXCEEDING 0.27 BTU • INCH / (HR • FT² • °F)
 - ALL PIPE INSULATION MUST HAVE A FLAME SPREAD LESS THAN 25 AND A SMOKE-DEVELOPED INDEX OF NOT MORE THAN 50 WHEN TESTED IN ACCORDANCE WITH ASTM E84 OR UL723.
 - NO PLASTIC PIPING IS ALLOWED IN AIR PLENUMS.
 - ANY CONNECTIONS THAT ARE DISSIMILAR METALS SHALL REQUIRE A DIELECTRIC NIPPLE. DIELECTRIC UNIONS ARE NOT ALLOWED.
 - PROVIDE FIBERGLASS ALL SERVICE JACKET (ASJ).
 - ASJ TO BE SEALED AT ALL SEAMS AND EDGES.
 - PROVIDE PVC COATED JACKET ON ALL EXPOSED PIPING.

SYSTEM	ABBREV	PIPE MATERIAL	INSULATION
DOMESTIC COLD WATER < 1-1/2"ø	DCW	L' COPPER / PEX	1/2"
DOMESTIC HOT WATER < 1-1/2"ø	DHW	L' COPPER / PEX	1"
DOMESTIC HOT WATER RECIRC < 1-1/2"ø	DHWR	L' COPPER / PEX	1"
WASTE PIPE - ABOVE GRADE	SAN	SCHEDULE 40 PVC	NONE
SANITARY SEWER - BELOW GRADE	SAN	SCHEDULE 40 PVC	NONE
VENT	V	SCHEDULE 40 PVC	NONE



MSU-CPDC
MONTANA STATE UNIVERSITY
BOZEMAN, MONTANA
PHONE: 406.994.5413
FAX: 406.994.5665

BID SET
VISUAL COMMUNICATIONS
DARKROOMS 135 & 138 SINK
REPLACEMENT
MONTANA STATE UNIVERSITY



DRAWN BY: **LAG**

REVIEWED BY: **JRH**

REV.	DESCRIPTION	DATE

PPA#20-0006

A/E#23061.01

MMI#6161.011

SHEET TITLE
PLUMBING
SPECIFICATIONS

SHEET
P002

DATE
04-25-2024

DRAWN BY: LAG		
REVIEWED BY: JRH		
REV.	DESCRIPTION	DATE

PPA#20-0006
A/E#23061.01
MMI#6161.011

SHEET TITLE
PLUMBING
UNDERSLAB DEMO
PLAN

SHEET
PD100

DATE
04-25-2024

PLUMBING DEMO NOTES

- A. LOCATIONS AND DIMENSIONS OF EXISTING FACILITIES IDENTIFIED ON THIS DRAWING ARE APPROXIMATE AND REPRESENT THE BEST AVAILABLE INFORMATION BASED ON A COMBINATION OF FIELD INVESTIGATIONS AND VARIOUS DESIGN AND RECORD DRAWINGS AVAILABLE AT THE TIME OF DESIGN. FIELD VERIFY LOCATIONS AND DIMENSIONS PRIOR TO ORDERING EQUIPMENT AND DURING PERFORMANCE OF THE WORK. PROVIDE DEMOLITION WORK, NECESSARY FITTINGS, TRANSITIONS, AND OTHER COMPONENTS AS REQUIRED FOR A COMPLETE AND FUNCTIONAL INSTALLATION OF NEW SYSTEMS AT NO ADDITIONAL COST TO THE OWNER.
- B. EXISTING PLUMBING EQUIPMENT, FIXTURES, AND PIPING SHOWN AS DARK AND DASHED SHALL BE DEMOLISHED. EXISTING PLUMBING EQUIPMENT, FIXTURES, AND PIPING SHOWN LIGHT SHALL REMAIN UNCHANGED.
- C. THE PLUMBING CONTRACTOR SHALL COORDINATE SALVAGE OF REMOVED EQUIPMENT IN GOOD CONDITION WITH THE OWNER. THE PLUMBING CONTRACTOR SHALL DISPOSE OF UNWANTED EQUIPMENT.
- D. COORDINATE WITH GENERAL CONTRACTOR TO PATCH AND REPAIR ROOF AND WALL ASSEMBLIES ASSOCIATED WITH PLUMBING DEMOLITION.
- E. CONCRETE SLAB CUTTING REGIONS SHOWN ON DRAWINGS ARE APPROXIMATE AND MUST BE FIELD COORDINATED PRIOR TO THE CUTTING OF THE SLAB.
- F. PROTECT EXISTING BUILDING ELEMENTS DURING DEMOLITION WORK. COORDINATE WITH OTHER TRADES TO ENSURE NO EXISTING EQUIPMENT/PIPING TO REMAIN IS DAMAGED DURING THE DEMOLITION WORK.

KEY NOTES:

- 1. SAW CUT AREA INDICATED FOR INSTALLATION OF NEW TRENCH DRAIN. FIELD COORDINATE EXTENTS OF PLUMBING PIPING.

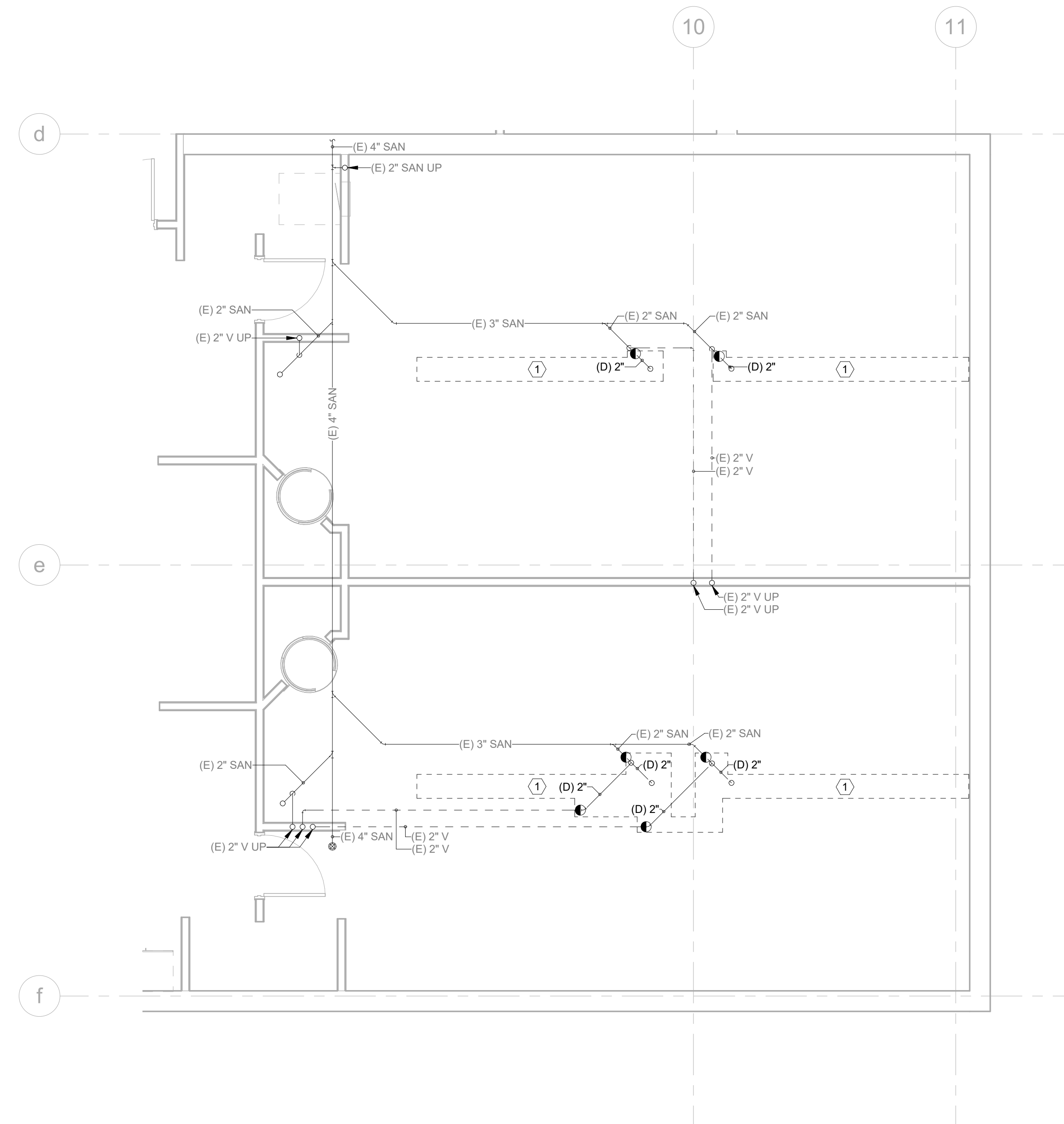

1 PLUMBING UNDERSLAB DEMO PLAN
1/4" = 1'-0"

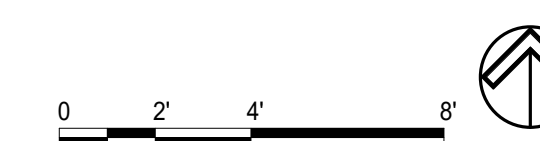

REV.	DESCRIPTION	DATE

PPA#20-0006
A/E#23061.01
MMI#6161.011

SHEET TITLE
PLUMBING DEMO
PLAN

SHEET
PD101

DATE
04-25-2024

PLUMBING DEMO NOTES

- A. LOCATIONS AND DIMENSIONS OF EXISTING FACILITIES IDENTIFIED ON THIS DRAWING ARE APPROXIMATE AND REPRESENT THE BEST AVAILABLE INFORMATION BASED ON A COMBINATION OF FIELD INVESTIGATIONS AND VARIOUS DESIGN AND RECORD DRAWINGS AVAILABLE AT THE TIME OF DESIGN. FIELD VERIFY LOCATIONS AND DIMENSIONS PRIOR TO ORDERING EQUIPMENT AND DURING PERFORMANCE OF THE WORK. PROVIDE DEMOLITION WORK, NECESSARY FITTINGS, TRANSITIONS, AND OTHER COMPONENTS AS REQUIRED FOR A COMPLETE AND FUNCTIONAL INSTALLATION OF NEW SYSTEMS AT NO ADDITIONAL COST TO THE OWNER.
- B. EXISTING PLUMBING EQUIPMENT, FIXTURES, AND PIPING SHOWN AS DARK AND DASHED SHALL BE DEMOLISHED. EXISTING PLUMBING EQUIPMENT, FIXTURES, AND PIPING SHOWN LIGHT SHALL REMAIN UNCHANGED.
- C. THE PLUMBING CONTRACTOR SHALL COORDINATE SALVAGE OF REMOVED EQUIPMENT IN GOOD CONDITION WITH THE OWNER. THE PLUMBING CONTRACTOR SHALL DISPOSE OF UNWANTED EQUIPMENT.
- D. COORDINATE WITH GENERAL CONTRACTOR TO PATCH AND REPAIR ROOF AND WALL ASSEMBLIES ASSOCIATED WITH PLUMBING DEMOLITION.
- E. CONCRETE SLAB CUTTING REGIONS SHOWN ON DRAWINGS ARE APPROXIMATE AND MUST BE FIELD COORDINATED PRIOR TO THE CUTTING OF THE SLAB.
- F. PROTECT EXISTING BUILDING ELEMENTS DURING DEMOLITION WORK. COORDINATE WITH OTHER TRADES TO ENSURE NO EXISTING EQUIPMENT/PIPING TO REMAIN IS DAMAGED DURING THE DEMOLITION WORK.

KEY NOTES:

- 1. DEMOLISH MIXING VALVE. 3/4" DCW, 3/4" DHW, 3/4" TW TO REMAIN FOR NEW UNIT.

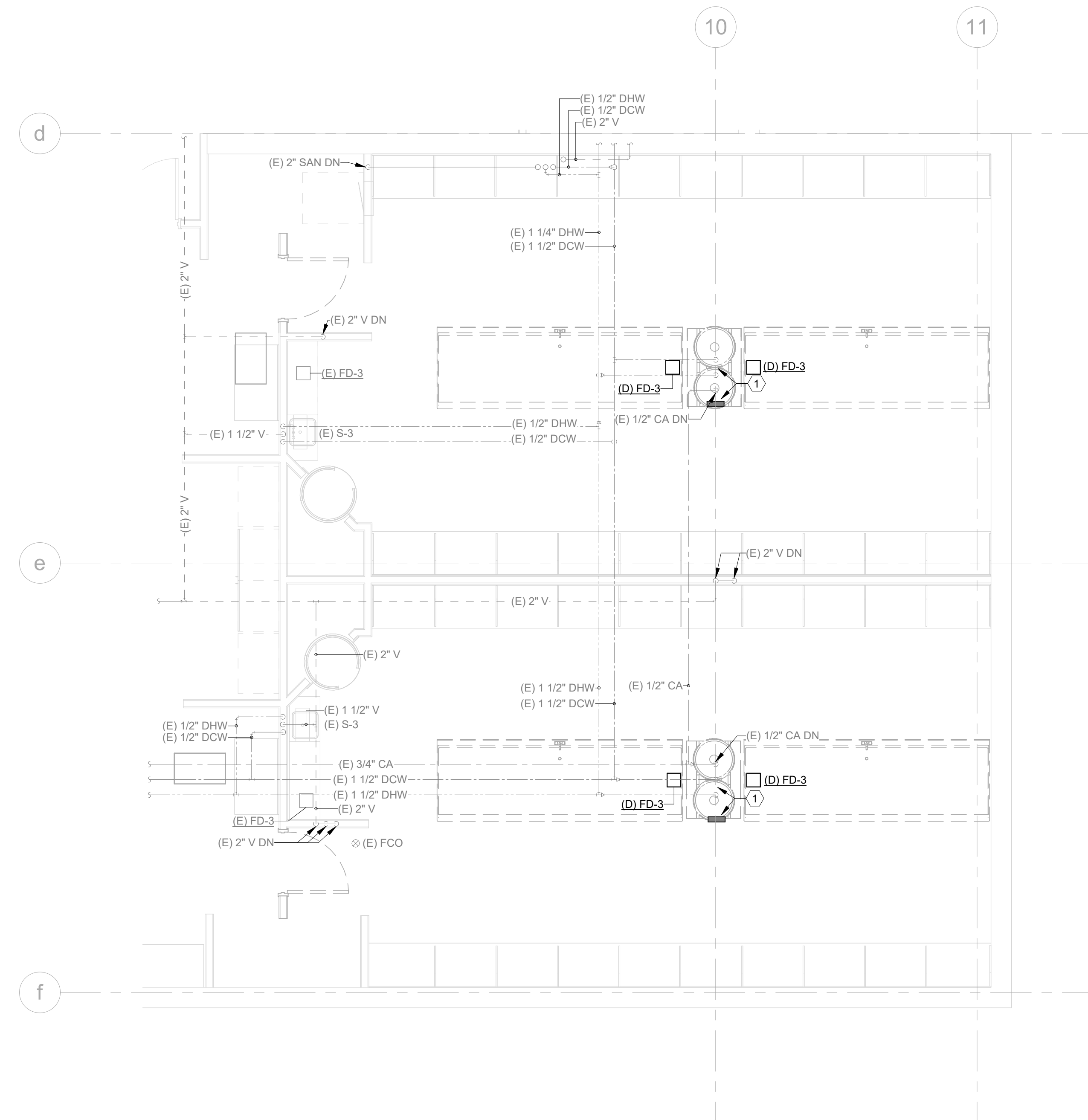

1 PLUMBING DEMO FLOOR PLAN
1/4" = 1'-0"

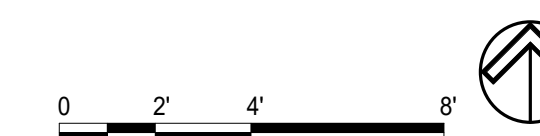

DRAWN BY: LAG		
REVIEWED BY: JRH		
REV.	DESCRIPTION	DATE

PPA#20-0006
A/E#23061.01
MMI#6161.011

SHEET TITLE
PLUMBING
UNDERSLAB PLAN

SHEET
P100

DATE
04-25-2024

PLUMBING PLAN NOTES

- A. PROVIDE ACCESS DOORS TO ALLOW SERVICE AND INSPECTION OF EQUIPMENT, VALVES, AND OTHER DEVICES INSTALLED ABOVE NON-REMOVABLE CEILINGS. COORDINATE SUCH INSTALLATIONS WITH ARCHITECT AND ENGINEER.
- B. PROVIDE TRAP SEALS AND TRAP PRIMERS FOR FLOOR DRAINS, FLOOR SINKS, AND OTHER FLOOR RECEPTORS.
- C. INSTALL ACCESSIBLE PLUMBING FIXTURES IN COMPLIANCE WITH ADA REQUIREMENTS. INSULATE EXPOSED PIPING BELOW ADA ACCESSIBLE FIXTURES.
- D. INSTALL FLOOR DRAIN STRAINERS AND CLEANOUT COVERS FLUSH AND LEVEL WITH FINISHED FLOOR.
- E. PIPING SHALL BE IDENTIFIED WITH PIPE LABELS MARKED AT A MAXIMUM OF EVERY 25 FT. VALVES SHALL BE IDENTIFIED WITH BRASS OR ALUMINUM VALVE TAGS.
- F. PROVIDE AND INSTALL PIPE GUIDES, EXPANSION JOINTS, AND HANGERS PER MANUFACTURER'S RECOMMENDATIONS.
- G. PIPING WALL PENETRATIONS SHALL BE FINISHED WITH A CHROME ESCUTCHEON PLATE.
- H. NO FITTINGS OR PIPING CONNECTIONS SHALL BE INSTALLED UNDERSLAB.
- I. GAS PIPING IS TO BE WELDED IN CONCEALED SPACES.
- J. REFER TO THE PLUMBING FIXTURE SCHEDULE FOR PIPE SIZES TO INDIVIDUAL FIXTURES.
- K. COORDINATE CONCRETE PENETRATIONS WITH STRUCTURAL DRAWINGS TO VERIFY HOW AND WHERE CONCRETE CAN BE CUT.
- L. EXPOSED PIPING SHALL BE PAINTED PER ARCHITECTURAL OR PROVIDED WITH A PVC COATED JACKET IN THE COLOR OF THE ARCHITECT'S CHOOSING. CONTRACTOR TO CLEAN AND DRY PIPING PRIOR TO PAINTING.
- M. SANITARY SEWER, RAINWATER, AND OTHER DRAIN PIPING SHALL BE INSTALLED AT A MINIMUM 1/4" PER FOOT (2%) SLOPE IN DIRECTION OF FLOW, UNLESS OTHERWISE INDICATED ON THE DRAWINGS.

KEY NOTES:

- 1. 2" SAN UP TO TD-1

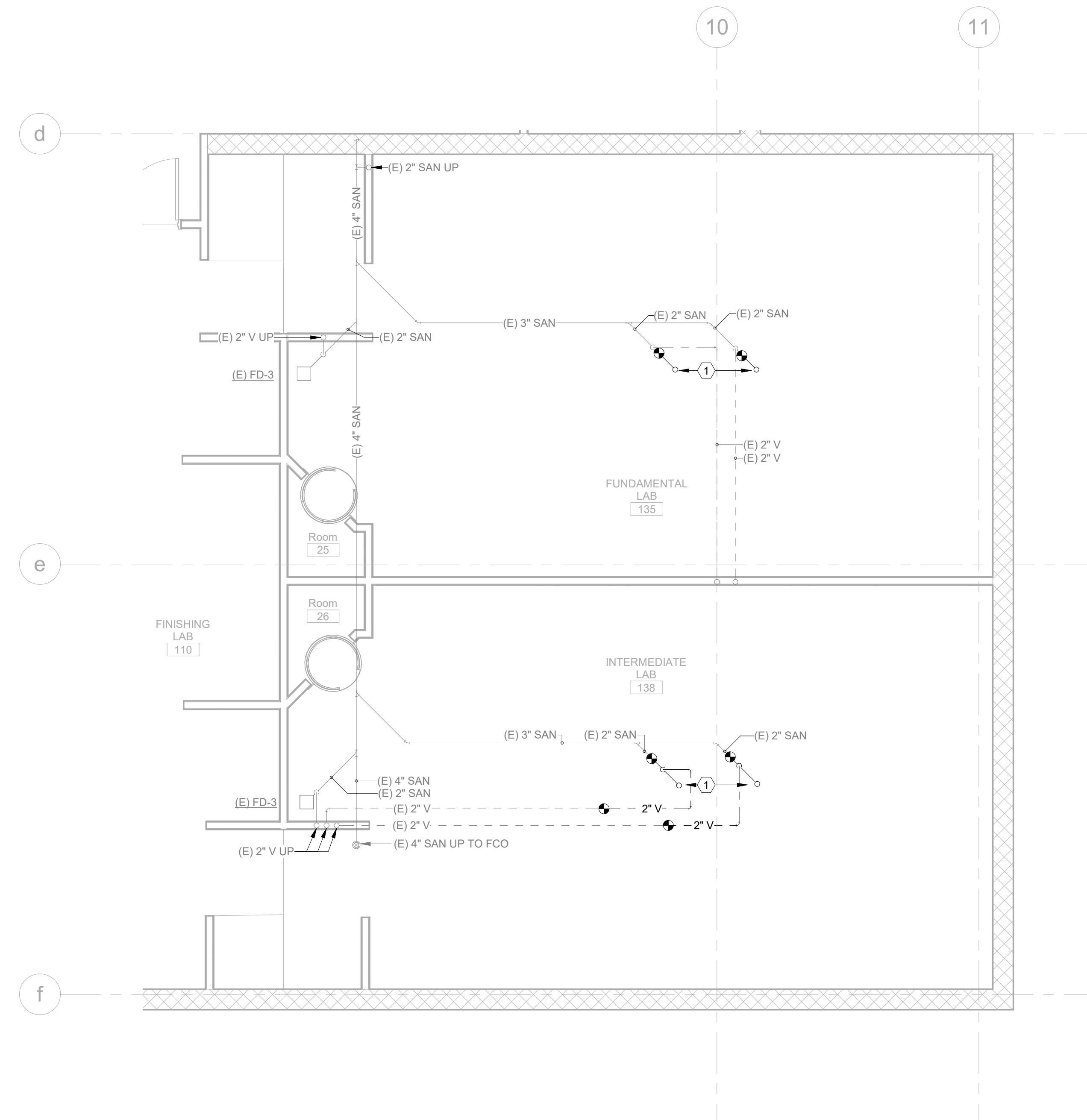

1 PLUMBING UNDERSLAB PLAN
1/4" = 1'-0"



REV.	DESCRIPTION	DATE

PLUMBING PLAN NOTES

- A. PROVIDE ACCESS DOORS TO ALLOW SERVICE AND INSPECTION OF EQUIPMENT, VALVES, AND OTHER DEVICES INSTALLED ABOVE NON-REMOVABLE CEILINGS. COORDINATE SUCH INSTALLATIONS WITH ARCHITECT AND ENGINEER.
- B. PROVIDE TRAP SEALS AND TRAP PRIMERS FOR FLOOR DRAINS, FLOOR SINKS, AND OTHER FLOOR RECEPTORS.
- C. INSTALL ACCESSIBLE PLUMBING FIXTURES IN COMPLIANCE WITH ADA REQUIREMENTS. INSULATE EXPOSED PIPING BELOW ADA ACCESSIBLE FIXTURES.
- D. INSTALL FLOOR DRAIN STRAINERS AND CLEANOUT COVERS FLUSH AND LEVEL WITH FINISHED FLOOR.
- E. PIPING SHALL BE IDENTIFIED WITH PIPE LABELS MARKED AT A MAXIMUM OF EVERY 25 FT. VALVES SHALL BE IDENTIFIED WITH BRASS OR ALUMINUM VALVE TAGS.
- F. PROVIDE AND INSTALL PIPE GUIDES, EXPANSION JOINTS, AND HANGERS PER MANUFACTURER'S RECOMMENDATIONS.
- G. PIPING WALL PENETRATIONS SHALL BE FINISHED WITH A CHROME ESCUTCHEON PLATE.
- H. NO FITTINGS OR PIPING CONNECTIONS SHALL BE INSTALLED UNDERSLAB.
- I. GAS PIPING IS TO BE WELDED IN CONCEALED SPACES.
- J. REFER TO THE PLUMBING FIXTURE SCHEDULE FOR PIPE SIZES TO INDIVIDUAL FIXTURES.
- K. COORDINATE CONCRETE PENETRATIONS WITH STRUCTURAL DRAWINGS TO VERIFY HOW AND WHERE CONCRETE CAN BE CUT.
- L. EXPOSED PIPING SHALL BE PAINTED PER ARCHITECTURAL OR PROVIDED WITH A PVC COATED JACKET IN THE COLOR OF THE ARCHITECT'S CHOOSING. CONTRACTOR TO CLEAN AND DRY PIPING PRIOR TO PAINTING.
- M. SANITARY SEWER, RAINWATER, AND OTHER DRAIN PIPING SHALL BE INSTALLED AT A MINIMUM 1/4" PER FOOT (2%) SLOPE IN DIRECTION OF FLOW, UNLESS OTHERWISE INDICATED ON THE DRAWINGS.

KEY NOTES:

- 1. MOUNT TV-1 IN AN ACCESSIBLE LOCATION IN OVERHEAD UNIT. CONNECT EXISTING 3/4" DCW, 3/4" DHW, AND 3/4" TW TO TEMPERING VALVE. COORDINATE ELECTRICAL CONNECTION WITH ELECTRICAL CONTRACTOR.
- 2. PROVIDE THREADED CONNECTION BETWEEN ELBOW AND DISCHARGE PIPE FOR THE ABILITY TO CHANGE PIPE LENGTHS. PROVIDE 2 EXTRA THREADED DISCHARGE PIPE SECTIONS PER TABLE SIZED TO DISCHARGE INTO TRENCH DRAIN. STANDARD DISCHARGE HEIGHT SHALL BE VERIFIED WITH CHEMICAL CONTAINERS.

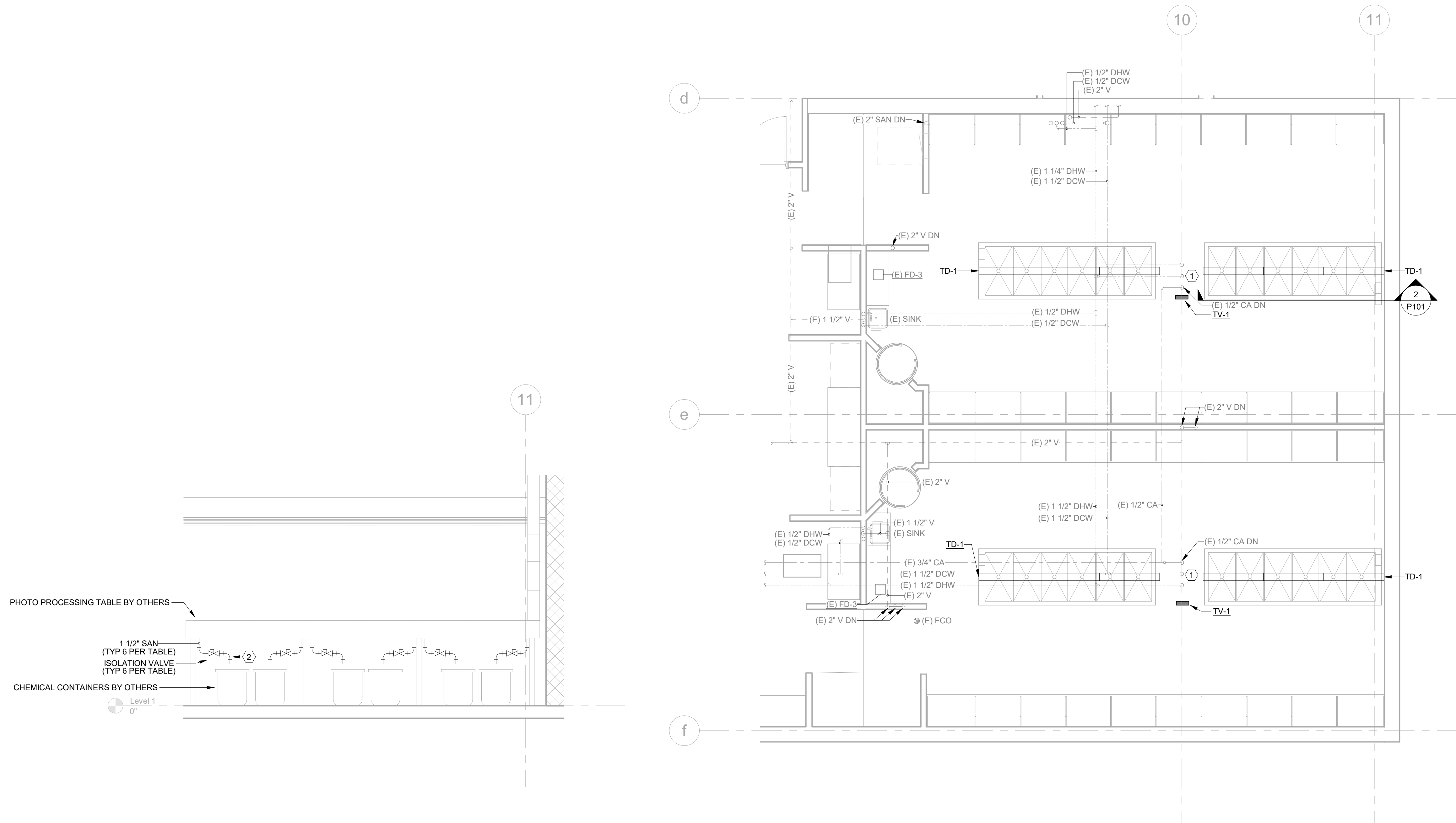

2 TABLE SECTION - PLUMBING
1/2" = 1'-0"

1 PLUMBING FLOOR PLAN
1/4" = 1'-0"

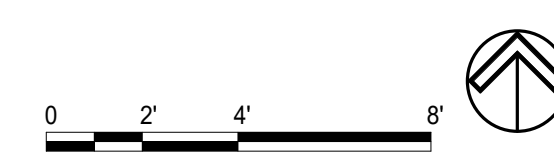

ELECTRICAL ABBREVIATIONS LEGEND

A, AMP	AMPERES	MAG	MAGNETIC STARTER
AC	ALTERNATING CURRENT	MAN	MANUAL
AC	AIR CONDITIONING	MAX	MAXIMUM
AF	AMP FUSE	MC	MECHANICAL CONTRACTOR
AFC	AVAILABLE FAULT CURRENT	MCA	MINIMUM CIRCUIT AMPACITY
AFCI	ARC FAULT CIRCUIT INTERRUPTER	MCC	MOTOR CONTROL CENTER
AFF	ABOVE FINISHED FLOOR	MDF	MAIN DISTRIBUTION PANEL
AFG	ABOVE FINISHED GRADE	MECH	MECHANICAL
AHU	AIR HANDLING UNIT	MEP	MECHANICAL, ELECTRICAL, PLUMBING
AL	ALUMINUM	MH	METAL HALIDE
AS	AMP SWITCH	MIN	MINIMUM
ATS	AUTOMATIC TRANSFER SWITCH	MSS	MOTOR STARTER SWITCH WITH THERMAL OVERLOADS
BAS	BUILDING AUTOMATION SYSTEM	N	NEUTRAL
BKR	BREAKER	NC	NORMALLY CLOSED
BOF	BOTTOM OF FIXTURE	NEC	NATIONAL ELECTRIC CODE
C	RACEWAY/CONDUIT	NEMA	NATIONAL ELECTRICAL MANUFACTURERS ASSOCIATION
CB	CIRCUIT BREAKER	NFD	NON-FUSED DISCONNECT
CCT	COLOR RENDERING TEMPERATURE	NL	NIGHT LIGHT, UN-SWITCHED 24/7 OPERATION
CCTV	CLOSED CIRCUIT TELEVISION	NIC	NOT IN CONTRACT
CKT	CIRCUIT	NO	NORMALLY OPEN
CLG	CEILING	#	NUMBER
C.O.	RACEWAY/CONDUIT ONLY, WITH PULL STRING	OAE	OR APPROVED EQUAL
COD	CENTER OF DEVICE	OC	ON CENTER
CNTRL	CONTROL	OCPD	OVERCURRENT PROTECTIVE DEVICE
CU	COPPER	OH	OVERHEAD
(D)	EXISTING TO BE DEMOLISHED	P	POLE
DISC	DISCONNECT	PB	PUSHBUTTON
DIST	DISTRIBUTION	PC	PLUMBING CONTRACTOR
DPDT	DOUBLE POLE DOUBLE THROW	PH	PHASE
DWG	DRAWING	PNL	PANEL
EA	EACH	PVC	POLYVINYL CHLORIDE CONDUIT
EC	ELECTRICAL CONTRACTOR	PWR	POWER
EF	EXHAUST FAN	(R)	EXISTING TO REMAIN
ELEC	ELECTRIC	RCPT	RECEPTACLE
EMT	ELECTRICAL METALLIC TUBING	RECEPT	RECEPTACLE
EQUIP	EQUIPMENT	RGS	RIGID GALVANIZED STEEL
EX, EXIST	EXISTING	RM	ROOM
FA	FIRE ALARM	RVNR	REDUCED VOLTAGE NON-REVERSING
FAA	FIRE ALARM ANNUNCIATOR	RVR	REDUCED VOLTAGE REVERSING
FACP	FIRE ALARM CONTROL PANEL	SP	SINGLE POLE TOGGLE SWITCH
FD	FUSED DISCONNECT	SPD	SURGE PROTECTIVE DEVICE (TVSS)
FLR	FLOOR	SPEC	SPECIFICATION
FO	FIBER OPTIC	SPST	SINGLE POLE SINGLE THROW
FSD	FIRE SMOKE DAMPER RELAY, CONTROLLED BY ASSOCIATED SMOKE DETECTOR AND CIRCUITED BACK TO FACP	SSPB	START-STOP PUSHBUTTON
		SW	SWITCH
FVNR	FULL VOLTAGE NON-REVERSING	SWBD	SWITCHBOARD
FVR	FULL VOLTAGE REVERSING	SWGR	SWITCHGEAR
GEC	GROUNDING ELECTRODE CONDUCTOR	TB	TELEPHONE BOARD
GFCI	GROUND FAULT CIRCUIT INTERRUPTER	TC	TIME CLOCK
GFI	GROUND FAULT INTERRUPTER	TD	TIME DELAY
GFP	GROUND FAULT PROTECTION	TEL	TELEPHONE
GND	GROUND	TR	TAMPER RESISTANT
GRC	GALVANIZED RIGID CONDUIT	TR	TWISTED SHIELDED PAIR
HID	HIGH INTENSITY DISCHARGE	TSP	TELEPHONE TERMINAL BOARD
HOA	HAND-OFF-AUTOMATIC	TYP	TYPICAL
HP	HORSEPOWER	UG	UNDERGROUND
HPS	HIGH PRESSURE SODIUM	UH	UNIT HEATER
HTR	HEATER	UNO	UNLESS NOTED OTHERWISE
HVAC	HEATING, VENTILATION & AIR CONDITIONING	V	VOLT
HZ	HERTZ	VA	VOLT-AMPERES
J-BOX	JUNCTION BOX	VFD	VARIABLE FREQUENCY DRIVE
KVA	KILOVOLT-AMPERES	W	WATTS
KW	KILOWATTS	WAO	WORK AREA OUTLET
LCP	LIGHTING CONTROL PANEL	WP	WEATHERPROOF
LPW	LUMENS PER WATT	W/O	WITHOUT
LTG	LIGHTING	XFMR	TRANSFORMER
LM	LUMENS	Y	WYE-CONNECTED
LV	LOW VOLTAGE	Δ	DELTA-CONNECTED
		ø	PHASE

ELECTRICAL LIGHTING FIXTURE LEGEND

	RECESSED LED FIXTURE - "a" & "b" DESIGNATES SWITCH		EXIT SIGN - WALL MOUNT, CEILING MOUNT. ARROW INDICATES DIRECTION OF TRAVEL, SHADING INDICATES LIGHTED FACE.
	RECESSED EMERGENCY LED FIXTURE - "a" & "b" DESIGNATES SWITCH		COMBINATION EXIT SIGN/ EGRESS LIGHTING UNIT - WALL MOUNT, CEILING MOUNT. ARROW INDICATES DIRECTION OF TRAVEL, SHADING INDICATES LIGHTED FACE.
	SURFACE LED FIXTURE - "a" & "b" DESIGNATES SWITCH		DUAL HEAD EMERGENCY EGRESS BATTERY PACK, WALL MOUNT OR CEILING MOUNT
	SURFACE EMERGENCY LED FIXTURE - "a" & "b" DESIGNATES SWITCH		WALL MOUNTED SCENCE
	SURFACE WALL MOUNT LED FIXTURE		SURFACE DOWNLIGHT
	LED STRIP OR INDUSTRIAL, SURFACE OR CHAIN HUNG		SURFACE EMERGENCY DOWNLIGHT
	EMERGENCY LED STRIP OR INDUSTRIAL, SURFACE OR CHAIN HUNG		RECESSED CAN DOWNLIGHT
	POLE MOUNTED FIXTURE		RECESSED CAN EMERGENCY DOWNLIGHT
	LIGHTED BOLLARD		RECESSED CAN WALL WASHER
	PENDANT FIXTURE; HIGH BAY, LOW BAY, DECORATIVE		TRACK LIGHTING. SEE FIXTURE SCHEDULE AND LIGHTING PLANS.

ELECTRICAL LIGHTING CONTROL LEGEND

STANDARD LIGHTING CONTROLS: SWITCHES AND LINE VOLTAGE DIMMERS		DIGITAL LIGHTING CONTROLS: ROOM CONTROLLERS AND LOW VOLTAGE DEVICES	
	TOGGLE SWITCH (MOUNT AT +48", UNO) X - INDICATES LINE TYPE BLANK - SINGLE POLE 3 - INDICATES THREE-WAY 4 - INDICATES FOUR-WAY D - INDICATES DIMMER SWITCH PHILIPS SUNRISE - ON/OFF K - INDICATES KEYPAD SWITCH T - INDICATES TIMER P - INDICATES PILOT LIGHT OS - INDICATES WALL SWITCH OCC SENSOR WATTSTOPPER DW100 (SINGLE OR DUAL DW-200 SWITCH) OSD - INDICATES WALL SWITCH OCC SENSOR WITH 0-10V DIMMING - WATTSTOPPER DW-311 a - INDICATES SINGLE POLE LIGHTING SWITCH ZONE FOR ZONE a b - INDICATES SINGLE POLE LIGHTING SWITCH ZONE FOR ZONE b ab - INDICATES LIGHTING SWITCHES WITH MULTIPLE ZONES		OCCUPANCY SENSOR - DUAL TECHNOLOGY CEILING MOUNT: WATTSTOPPER LMDX-100, OR EQUAL WALL MOUNT: WATTSTOPPER LMLS-400, OR EQUAL WALL MOUNT AT +96", UNO
	PHOTOCELL - CEILING MOUNT, WATTSTOPPER LS-301, OR EQUAL		PHOTOCELL - CEILING MOUNT WATTSTOPPER LMLS-400, OR EQUAL
	ON/OFF ROOM CONTROLLER WITH (1) RELAY WATTSTOPPER DLM LMRC-101, OR EQUAL		ON/OFF ROOM CONTROLLER WITH (2) RELAYS WATTSTOPPER DLM LMRC-102, OR EQUAL
	ON/OFF/0-10V ROOM CONTROLLER WITH (2) RELAYS WATTSTOPPER DLM LMRC-212, OR EQUAL		ON/OFF/0-10V ROOM CONTROLLER WITH (3) RELAYS WATTSTOPPER DLM LMRC-213, OR EQUAL
	LOW VOLTAGE DIMMING SWITCH WATTSTOPPER DLM LMDM-101, OR EQUAL		LOW VOLTAGE DIMMING SWITCH WATTSTOPPER DLM LMSW-10#, OR EQUAL
	LOW VOLTAGE SWITCH, # INDICATES NUMBER OF BUTTONS, NO "#" IS A 2 BUTTON SWITCH WATTSTOPPER DLM LMSW-10#, OR EQUAL		

ELECTRICAL PROJECT GENERAL NOTES

- PRIOR TO BID CONTRACTOR SHALL VISIT THE SITE. NOT ALL WORK REQUIRED TO COMPLETE THE PROJECT IS SHOWN ON THE DRAWINGS. THE CONTRACTOR SHALL BECOME THOROUGHLY FAMILIAR WITH ALL THE WORK REQUIRED TO COMPLETE THE PROJECT IN ADDITION TO THE LOCAL CONDITIONS AND INCLUDE SAID WORK IN THE BID.
- GENERAL WORK PRACTICES FOR ELECTRICAL CONSTRUCTION SHALL BE IN ACCORDANCE WITH NECA 1, "STANDARD PRACTICES FOR GOOD WORKMANSHIP IN ELECTRICAL CONTRACTING." THIS PUBLICATION IS AVAILABLE FROM NECA BY TELEPHONE AT 301-657-3110 OR ON-LINE AT WWW.NECANET.ORG.
- IT IS THE CONTRACTORS RESPONSIBILITY TO COORDINATE WITH MECHANICAL FOR PLENUM SPACES AND PROVIDE PLENUM RATED CABLES WHERE REQUIRED FOR LIGHTING CONTROL AND ANY OTHER L.V. SYSTEMS NOT INSTALLED IN CONDUIT. VERIFY CONDUIT REQUIREMENTS ON DRAWINGS AND SPECIFICATIONS.
- FIRE-RESISTANCE: PROVIDE A MINIMUM HORIZONTAL DISTANCE OF 24" BETWEEN OUTLET BOXES LOCATED ON OPPOSITE SIDES OF FIRE-RESISTANCE RATED WALLS. WHERE THIS IS NOT POSSIBLE INSTALL UL LISTED PUTTY PADS ON ALL OUTLET BOXES NOT MEETING THE 24" SEPARATION. PROVIDE A UL LISTED THROUGH-PENETRATION FIRESTOP FOR PENETRATIONS OF FIRE-RESISTANCE RATED ASSEMBLIES.
- CONDUCTORS ARE SIZED PER THE 75 DEGREE C RATING COLUMN OF NEC TABLE 310.16. IF THE TERMINAL USED FOR A TERMINATION OF A PARTICULAR CONDUCTOR IS NOT MARKED, OR THE TERMINAL IS MARKED FOR 60 DEGREE C CONDUCTORS, IT IS THE RESPONSIBILITY OF THE CONTRACTOR TO EITHER ADJUST THE AMPACITY OF THE CONDUCTOR TO MATCH THE 60 DEGREE COLUMN OF TABLE 310.16, OR REPLACE THE TERMINAL WITH ONE RATED FOR AT LEAST 75 DEGREES C.
- BASED ON ACTUAL HOMERUN LENGTHS REQUIRED IN THE FIELD, THE CONTRACTOR SHALL CALCULATE AND INCREASE THE WIRE SIZES AS REQUIRED TO LIMIT BRANCH CIRCUIT VOLTAGE DROP TO 3%. FOR 20A BRANCH CIRCUITS THE MINIMUM CONDUCTOR SIZES SHALL BE AS FOLLOWS: #10 AWG CU FOR RUNS BETWEEN 100 AND 200 LINEAR FEET, #8 AWG CU FOR RUNS BETWEEN 200 AND 325 LINEAR FEET, AND AS CALCULATED BY THE CONTRACTOR FOR CIRCUITS EXTENDING BEYOND 325 LINEAR FEET. IN ALL CASES WHERE WIRE SIZES INCREASE, THE CONTRACTOR SHALL PROVIDE LARGER CONDUITS AS REQUIRED.
- PROVIDE A DEDICATED NEUTRAL CONDUCTOR FOR EACH 120V BRANCH CIRCUIT.

ELECTRICAL PROJECT DEMO NOTES

- DURING DEMOLITION, THE CONTRACTOR SHALL NOTE ALL EXISTING RACEWAY (BOTH SURFACE AND CONCEALED) TO THE EXTENT POSSIBLE. THESE RACEWAYS SHALL BE REUSED TO THE GREATEST EXTENT POSSIBLE TO INSURE A CLEAN FINISHED PRODUCT. WHERE PRACTICAL, AND ALLOWED PER CODE, FISHING THROUGH WALLS WITH MC CABLE IS PREFERRED TO SURFACE-MOUNTED CONDUIT.
- CONTRACTOR SHALL REMOVE, TRANSPORT, AND LEGALLY DISPOSE OF LAMPS AND BALLASTS OFF-SITE. IT IS ASSUMED THAT THE BALLASTS DO NOT CONTAIN PCBs. THE CONTRACTOR SHALL NOTIFY THE OWNER IMMEDIATELY IF IT IS SUSPECTED THAT BALLASTS CONTAIN PCBs.
- ALL POWER INTERRUPTIONS SHALL BE COORDINATED WITH OWNER. ANY DISRUPTION OF WORKERS IN THE SPACE SHALL BE KEPT TO A MINIMUM AND BE COORDINATED WITH THE OWNER PRIOR TO WORK COMMENCING IN THAT SPACE.
- ELECTRICAL CONTRACTOR SHALL BE RESPONSIBLE FOR REPAIR OF ANY EXISTING CONDUIT OR FEEDER CIRCUITS THAT ARE INTENDED TO REMAIN THAT ARE SAW-CUT, OR OTHERWISE DAMAGED, AS PART OF THE DEMOLITION PROCESS. PROVISION FOR THIS WORK SHALL INCLUDE, BUT NOT BE LIMITED TO: ALL NECESSARY CONDUIT AND CONDUCTORS, MOUNTING ACCESSORIES AND LABOR, TO RESTORE THE SYSTEM TO ITS INTENDED FUNCTION.
- ELECTRICAL DRAWINGS SHOWING EXISTING BUILDING CONDITIONS, SUCH AS DEMOLITION DRAWINGS, EXISTING PANEL SCHEDULES, ETC ARE BASED ON RECORD DRAWINGS AND SITE VISITS. IF ACTUAL EXISTING CONDITIONS DIFFER FROM THOSE SHOWN ON DRAWINGS, PLEASE NOTIFY ENGINEER.

ABBREVIATIONS AND SYMBOLS GENERAL NOTES

- THE ABBREVIATIONS ON THIS SHEET COMPRISE A STANDARD LIST; NOT ALL ABBREVIATIONS APPEAR ON THIS PROJECT.
- THE SYMBOLS ON THIS SHEET COMPRISE A STANDARD LIST; NOT ALL SYMBOLS APPEAR ON THIS PROJECT.
- ALL MOUNTING HEIGHTS ARE TO CENTER OF DEVICE ABOVE FINISHED FLOOR, UNLESS NOTED OTHERWISE. ELECTRICAL CONTRACTOR SHALL COORDINATE WITH OTHER CONTRACTORS, MAKING ADJUSTMENTS AS REQUIRED TO AVOID INTERFERENCE WITH EQUIPMENT SUCH AS BASEBOARD FIN-TUBE, CABINET UNIT HEATERS, ETC. ARCHITECT/ENGINEER SHALL BE NOTIFIED OF ALL SUCH HEIGHT ADJUSTMENTS. MOUNTING HEIGHTS INDICATED ON ARCHITECTURAL WALL ELEVATIONS OR AS NOTED SPECIFICALLY ON THE DRAWINGS OR IN THE SPECIFICATIONS SHALL TAKE PRECEDENCE OVER MOUNTING HEIGHTS LISTED.

ELECTRICAL SHEET INDEX

NUMBER	SHEET NAME
E001	ELECTRICAL LEGENDS & NOTES
E002	ELECTRICAL SPECIFICATIONS
E100	ELECTRICAL DEMOLITION PLAN
E101	ELECTRICAL RENOVATION PLAN

LUMINAIRE SCHEDULE

TYPE	LAMPS	LOAD (W)	OUTPUT (LM NOMINAL)	CCT (K)	DESCRIPTION	MFR	CATALOG NO. OR SERIES	MOUNTING	VOLTAGE	NOTES
B1	LED	4 W	50	660NM	1'X1' DARK ROOM SAFE-LIGHT WITH RED (660NM) SOURCE	KURTZON	DKS-F/G-2-1X1-RED-UNV-FROST-INTDIM	RECESSED	120 V	1,2
B2	LED	9 W	134	660NM & 590NM	1'X2' DARK ROOM SAFE-LIGHT WITH RED (660NM) & AMBER (590NM) SOURCE. EACH SOURCE TO BE CONTROLLED (DIMMED) SEPARATELY.	KURTZON	DKS-F/G-2-1X2-RED-AMB-UNV-FROST-WHT-D2OFF	RECESSED	120 V	1,2

NOTES:

- ANY ALTERNATE SUBSTITUTE LIGHT FIXTURE REQUIRES PRIOR APPROVAL BEFORE BID. FOLLOW ALL PROJECT SUBSTITUTION REQUIREMENTS, INCLUDING COMPLETION OF MSU SUBSTITUTION REQUEST FORM.
- PROVIDE WITH 0-10V DIMMING.

GENERAL NOTES:

- ALL LUMINAIRES SHALL BE TESTED AND LISTED BY A NATIONALLY RECOGNIZED TESTING LABORATORY (NRTL) SUCH AS UL OR ETL.
- THE ELECTRICAL CONTRACTOR SHALL VERIFY ALL CEILING TYPES AND PROVIDE ALL MOUNTING, FIRE-RATED, AND IC-RATED ACCESSORIES AS REQUIRED. FOR FIRE-RATED CEILING ASSEMBLIES AND FOR CEILINGS WITH INSULATION, VERIFY ALL RECESSED LUMINAIRE HOUSINGS ARE RATED APPROPRIATELY OR PROVIDE DROP-OVER ENCLOSURES OR TENTS FOR LUMINAIRES. VERIFY THAT DROP-OVER ENCLOSURES OR TENTS ALLOW FOR AIR SPACE AROUND LUMINAIRE PER MANUFACTURER'S RECOMMENDATIONS.

BID SET

VISUAL COMMUNICATIONS
DARKROOMS 135 & 138 SINK
REPLACEMENT
MONTANA STATE UNIVERSITY



DRAWN BY: SAJ

REVIEWED BY: RPM

REV. DESCRIPTION DATE

PPA#20-0006

A/E#23061.01

MMI#6161.011

SHEET TITLE

ELECTRICAL

LEGENDS & NOTES

SHEET

E001

DATE

04-25-2024

260010 - GENERAL REQUIREMENTS OF ELECTRICAL

- A. SUMMARY**
- THE REQUIREMENTS LISTED IN THIS SECTION ARE SUPPLEMENTAL TO THE DIVISION 01 GENERAL REQUIREMENTS.
 - IT SHALL BE THE RESPONSIBILITY OF THE ELECTRICAL CONTRACTOR TO EXAMINE AND REFER TO ALL ARCHITECTURAL, MECHANICAL & PLUMBING DRAWINGS AND SPECIFICATIONS FOR CONSTRUCTION CONDITIONS WHICH MAY AFFECT THE SCOPE OF ELECTRICAL WORK. INSPECT THE BUILDING SITE AND EXISTING FACILITIES FOR VERIFICATION OF PRESENT CONDITIONS. MAKE PROPER PROVISIONS FOR THESE CONDITIONS IN PERFORMANCE OF THE WORK AND COST THEREOF.
 - ELECTRICAL WORK FOR THIS PROJECT SHALL INCLUDE ALL ITEMS, ARTICLES, MATERIALS AND THE ASSOCIATED LABOR MENTIONED, SCHEDULES OR SHOWN IN THESE SPECIFICATIONS AND IN THE ACCOMPANYING DRAWINGS.
 - FURNISH AND INSTALL ALL EQUIPMENT, MATERIALS AND ANY REQUIRED INCIDENTAL ITEMS REQUIRED BY GOOD PRACTICE TO COMPLETE THE SYSTEMS DESCRIBED HEREIN.
- B. DEFINITIONS -** THROUGHOUT CONTRACT DOCUMENTS THESE WORDS AND PHRASES ARE USED:
- CONTRACT DOCUMENTS - ALL DRAWINGS, SPECIFICATIONS, ADDENDA AND CHANGE ORDERS THAT DOCUMENT WORK TO BE DONE.
 - DEMOLITION - CAREFULLY DISCONNECT AND REMOVE ITEMS. ALL REASONABLE CAUTION SHALL BE TAKEN TO AVOID DAMAGING REMOVED EQUIPMENT AND TO RETAIN ITS OPERABILITY.
 - REMOVE BACK TO SOURCE - REMOVE ALL CONDUIT AND WIRE BACK TO PANELBOARD OR LAST LIVE DEVICE.
 - EQUIVALENT OR EQUAL - PRODUCT OF LIKE TYPE AND FUNCTION THAT COMPLIES WITH ALL APPLICABLE PROVISIONS OF DRAWINGS AND SPECIFICATIONS AND WHICH HAS BEEN APPROVED AS SUBSTITUTE FOR SPECIFIED ITEM.
 - FURNISH - PURCHASE MATERIAL AS SHOWN AND SPECIFIED, AND PLACE MATERIAL AT APPROVED LOCATION ON SITE OR ELSEWHERE AS NOTED OR AGREED UPON.
 - INSTALL - SET IN PLACE AND CONNECT, READY FOR USE AND IN COMPLETE AND PROPERLY OPERATING FINISHED CONDITION.
 - PROVIDE - FURNISH AND INSTALL WITH ALL PRODUCTS, LABOR, SUB-CONTRACTS, AND APPURTENANCES REQUIRED FOR A COMPLETE AND PROPERLY OPERATING, FINISHED CONDITION.
 - ROUGH-IN - PROVIDE CONDUIT RACEWAY SYSTEM WITH JUNCTION BOXES, FITTINGS, STRAPS, BUSHINGS, ETC., FOR FUTURE INSTALLATION OF WIRING, DEVICES, DISCONNECTS AND BREAKERS. PROVISION SHALL BE MADE IN PANELBOARD (HARDWARE, ETC.) FOR FUTURE INSTALLATION OF BREAKERS.
 - REMOVE - WITH GENERAL CONTRACTOR SHALL BE THE DATE THAT THE SUBSTANTIAL COMPLETION CERTIFICATE IS ISSUED.
- C. CODES, STANDARDS AND REGULATIONS**
- CODES - PERFORM ALL WORK IN STRICT ACCORDANCE WITH ALL APPLICABLE REGULATIONS, STANDARDS AND REGULATIONS, BUT NOT LIMITED TO LATEST LEGALLY ENACTED EDITIONS OF FOLLOWING CODES:
 - NFPA 70, NATIONAL ELECTRIC CODE - NEC
 - NFPA 72, NATIONAL FIRE ALARM CODE
 - ANSI-C2, NATIONAL ELECTRICAL SAFETY CODE - NESC
 - INTERNATIONAL BUILDING CODE - IBC
 - INTERNATIONAL FIRE CODE - IFC
 - INTERNATIONAL ENERGY CONSERVATION CODE - IECC
 - STANDARDS - REFERENCE TO STANDARDS INFERS THAT INSTALLATION, EQUIPMENT AND MATERIAL SHALL BE WITHIN LIMITS FOR WHICH IT WAS DESIGNED, TESTED AND APPROVED. THIS COMPONENT OR PRODUCT IN QUESTION PUBLICATIONS AND STANDARDS OF FOLLOWING ORGANIZATIONS:
 - AMERICAN NATIONAL STANDARDS INSTITUTE - ANSI
 - AMERICAN SOCIETY FOR TESTING AND MATERIALS - ASTM
 - AMERICAN SOCIETY OF HEATING REFRIGERATING AND AIR CONDITIONING ENGINEERS - ASHRAE (STANDARD 90.75)
 - INSTITUTE OF ELECTRICAL AND ELECTRONICS ENGINEERS - IEEE
 - INSULATED CABLE ENGINEERS ASSOCIATION - ICEA
 - NATIONAL ELECTRICAL CONTRACTORS ASSOCIATION - NECA
 - NATIONAL ELECTRICAL MANUFACTURERS' ASSOCIATION - NEMA
 - NATIONAL FIRE PROTECTION ASSOCIATION - NFPA
 - OCCUPATIONAL SAFETY AND HEALTH ADMINISTRATION - OSHA
 - UNDERWRITERS' LABORATORIES, INC. - UL
 - RULES AND REGULATIONS OF THE STATE/LOCAL FIRE MARSHAL
 - STANDARDS AND REQUIREMENT OF THE SERVING UTILITIES
 - STATE AND LOCAL ORDINANCES
 - REGULATIONS - DESIGN HAS BEEN PERFORMED IN ACCORDANCE WITH APPLICABLE REGULATIONS AND GUIDELINES NOTED BELOW. CONTRACTOR SHALL CAREFULLY APPLY THESE REGULATIONS AND BRING ANY DISCREPANCIES TO IMMEDIATE ATTENTION OF ARCHITECT/ENGINEER.
 - AMERICANS WITH DISABILITIES ACT - ADA
- D. FEES AND PERMITS**
- ELECTRICAL CONTRACTOR SHALL PAY FOR ALL PERMITS OR FEES IN CONNECTION WITH ELECTRICAL WORK. FEES SHALL INCLUDE ANY OR ALL USER FEES, GOVERNMENT FEES, SYSTEM DEVELOPMENT FEES, CONNECTION FEES OR OTHER FEES THAT ARE REQUIRED TO BE PAID BEFORE SYSTEMS CAN BE CONNECTED OR USED.
 - SCHEDULE ALL REQUIRED ELECTRICAL INSPECTIONS WITH LOCAL ELECTRICAL INSPECTOR. NOTIFY ENGINEER OF ALL ITEMS OF DISCREPANCY NOTED BY ELECTRICAL INSPECTOR IF THOSE ITEMS AFFECT COST OR FUNCTION OF SYSTEM, OR IF THEY CONFLICT WITH ELECTRICAL DRAWINGS AND SPECIFICATIONS.
 - DELIVER ALL INSPECTION CERTIFICATES TO ARCHITECT/ENGINEER PRIOR TO FINAL ACCEPTANCE OF WORK.
- E. INTENT OF SPECIFICATIONS AND DRAWINGS**
- PLANS AND SPECIFICATIONS ARE INTENDED TO RESULT IN COMPLETE ELECTRICAL INSTALLATION IN FULL COMPLIANCE WITH ALL APPLICABLE CODES, STANDARDS AND ORDINANCES.
 - PLANS AND SPECIFICATIONS ARE TO SUPPLEMENT EACH OTHER AND ANY DETAILS CONTAINED IN ONE SHALL BE INCLUDED AS IF CONTAINED IN BOTH.
 - ELECTRICAL DRAWINGS SHALL SERVE AS WORKING DRAWINGS, BUT ARCHITECTURAL DRAWINGS SHALL TAKE PRECEDENCE IF ANY DIMENSIONAL DISCREPANCIES EXIST.
 - DRAWINGS ARE PARTLY DIAGRAMMATIC AND DO NOT SHOW ROUTING OF CONDUITS, EXACT LOCATION OF PRODUCTS, OR INSTALLATION FEATURES IN EXACT DETAIL. LOCATIONS OF DEVICES, FIXTURES AND EQUIPMENT ARE APPROXIMATE UNLESS DIMENSIONED.
 - RISER DIAGRAMS AND CONTROL SCHEMATICS ARE NOT TO SCALE AND DO NOT SHOW PHYSICAL ARRANGEMENT OF EQUIPMENT. DO NOT USE RISER DIAGRAMS OR SCHEMATICS TO OBTAIN LINEAL CONDUIT AND CABLING DISTANCES.
 - ITEMS ARE SHOWN ON DRAWINGS IN LOCATIONS TO MINIMIZE INTERFERENCE WITH OTHER EQUIPMENT, STRUCTURAL MEMBERS, ETC. EXACT FINISH LOCATIONS ARE NOT INDICATED, HOWEVER, AND ALL WORK SHALL BE DONE TO AVOID INTERFERENCE. PRESERVE HEADROOM AND KEEP OPENINGS AND PASSAGeways CLEAR.
 - IN EVENT THAT DISCREPANCIES OF ANY KIND EXIST OR REQUIRED ITEMS/DETAILS HAVE BEEN OMITTED, CONTRACTOR SHALL NOTIFY ARCHITECT/ENGINEER IN WRITING OF SUCH DISCREPANCY OR OMISSION AT LEAST TEN DAYS PRIOR TO BID DATE. FAILURE TO DO SO SHALL BE CONSTRUED AS WILLINGNESS OF CONTRACTOR TO SUPPLY ALL NECESSARY MATERIALS AND LABOR REQUIRED FOR PROPER COMPLETION OF WORK.
- F. CONTRACTOR'S RESPONSIBILITY -** CONTRACTOR SHALL BE RESPONSIBLE FOR INSTALLATION OF COMPLETE AND FUNCTIONAL PIECE OF WORK IN ACCORDANCE WITH TRUE INTENT OF CONTRACT DOCUMENTS. PROVIDE ALL INCIDENTAL ITEMS REQUIRED FOR COMPLETE INSTALLATION AND SATISFACTORY OPERATION OF ALL EQUIPMENT, WHETHER OR NOT SPECIFICALLY NOTED IN CONTRACT DOCUMENTS.
- QUALIFICATIONS
 - CONTRACTOR SHALL EMPLOY ON THIS PROJECT CAPABLE, EXPERIENCED AND RELIABLE FOREMAN AND SUCH SKILLED WORKMEN AS MAY BE REQUIRED FOR VARIOUS CLASSES OF WORK TO BE PERFORMED.
 - WHERE SPECIAL SKILLS AND CERTIFICATION ARE REQUIRED, CONTRACTOR SHALL ENSURE THAT WORK IS PERFORMED BY INDIVIDUALS WITH REQUIRED EXPERIENCE, SKILL AND CERTIFICATION.
 - REFER TO OTHER SPECIFICATION SECTIONS FOR ADDITIONAL REQUIRED CONTRACTOR QUALIFICATIONS AND CERTIFICATION.

- LICENSING AND CERTIFICATION - ALL DIVISION 26 WORK SHALL BE ACCOMPLISHED BY ELECTRICIANS, LICENSED BY STATE IN WHICH WORK IS BEING DONE, CERTIFIED AS REQUIRED, AND SKILLED IN THEIR CRAFT.
- COORDINATION
 - CONTRACTOR SHALL CONSULT ALL CONTRACT DOCUMENTS, SHOP DRAWINGS OF OTHER TRADES, AND ACTUAL BUILDING DIMENSIONS TO PREDETERMINE THAT HIS WORK AND EQUIPMENT WILL FIT AS PLANNED. DO NOT SCALE DRAWINGS FOR FABRICATION. NO EXTRA PAYMENT WILL BE ISSUED FOR MATERIALS OR ITEMS WHICH DO NOT FIT BECAUSE OF CONTRACTOR'S FAILURE TO VERIFY AS-BUILT BUILDING DIMENSIONS.
 - CONTRACTOR SHALL CHECK LOCATION OF FIXTURES, OUTLETS, EQUIPMENT, CONDUIT, ETC., TO DETERMINE THEY CLEAR ALL OPENINGS, STRUCTURAL MEMBERS, PIPING, DUCTS AND MISCELLANEOUS EQUIPMENT HAVING FIXED LOCATIONS.
 - CHANGES IN LOCATION OF ELECTRICAL WORK, NECESSARY DUE TO OBSTACLES OR INSTALLATION OF OTHER TRADES SHOWN ON CONTRACT DOCUMENTS, SHALL BE MADE BY ELECTRICAL CONTRACTOR AT NO EXTRA COST.
 - CONTRACTOR SHALL COORDINATE WITH PLUMBING AND MECHANICAL CONTRACTORS TO AVOID INSTALLATION OF PIPING AND DUCTWORK ABOVE OR BELOW PANELBOARDS IN VIOLATION OF NATIONAL ELECTRICAL CODE.
 - LAY OUT ALL WORK IN ADVANCE AND AVOID CONFLICT WITH OTHER WORK IN PROGRESS. PHYSICAL DIMENSIONS SHALL BE DETERMINED FROM ARCHITECTURAL AND STRUCTURAL PLANS. VERIFY LOCATIONS FOR JUNCTION BOXES, DISCONNECT SWITCHES, STUDS, UPS, ETC., FOR CONNECTION TO EQUIPMENT FURNISHED BY OTHERS, OR IN OTHER DIVISIONS OF THIS WORK.
 - CONTRACTOR SHALL COORDINATE AND PLAN WORK TO PROCEED WITH WORK OF OTHER TRADES.
 - CONTRACTOR SHALL INFORM GENERAL CONTRACTOR OF ALL REQUIRED OPENINGS IN BUILDING STRUCTURE FOR INSTALLATION OF ELECTRICAL EQUIPMENT.
 - CONTRACTOR SHALL CHECK DIMENSIONS OF ALL ELECTRICAL EQUIPMENT INSTALLED, PROVIDED BY HIMSELF OR BY OTHERS, SO CORRECT DISCREPANCIES AND CONNECTIONS CAN BE MADE TO SHOP DRAWINGS OF OTHER TRADES. CONTRACTOR SHALL DETERMINE WHERE ELECTRICAL JUNCTION/PULL BOXES AND EQUIPMENT CAN BE INSTALLED TO MAINTAIN PROPER ACCESSIBILITY. WHERE ACCESSIBILITY CANNOT BE MAINTAINED BY JUDICIOUS PLACEMENT OF BOXES, ELECTRICAL CONTRACTOR SHALL COORDINATE WITH GENERAL CONTRACTOR TO PROVIDE, FABRICATE, INSTALL, ADJUST, PAINT, ETC. ACCESS DOORS THROUGH NON-ACCESSIBLE FLOOR, WALL, AND CEILING FINISHES TO ALLOW ACCESS TO ALL ELECTRICAL JUNCTION AND PULL BOXES, ELECTRICAL DEVICES, ELECTRICAL EQUIPMENT, ETC. AT ALL REQUIRED LOCATIONS WHETHER SHOWN OR NOT SHOWN ON PLANS. ELABORATE CONTRACTOR IS RESPONSIBLE FOR DETERMINING SIZE AND LOCATION OF THE ACCESS DOORS. REPORT ANY CONFLICTS TO ARCHITECT/ENGINEER.
- WARRANTY
 - THE CONTRACTOR SHALL GUARANTEE THAT ALL MATERIALS AND LABOR INSTALLED AND FIRST MAINTENANCE OF EQUIPMENT THAT ANY MATERIAL OR LABOR FOUND DEFECTIVE SHALL BE REPLACED WITHOUT COST TO THE OWNER WITHIN ONE (1) YEAR AFTER SUBSTANTIAL COMPLETION OF THE CONTRACT OR ONE (1) FULL SEASON OF HEATING AND COOLING OPERATION, WHICHEVER IS THE GREATER. THE GUARANTEE SHALL LIST THE DATE OF THE BEGINNING OF THE OPERATION, WHICH SHALL BE THE DATE THAT THE SUBSTANTIAL COMPLETION CERTIFICATE IS ISSUED.
 - ANY DAMAGE TO THE BUILDING, CAUSED BY DEFECTIVE WORK OR MATERIAL OF THE CONTRACTOR WITHIN THE ABOVE-MENTIONED PERIOD, SHALL BE SATISFACTORILY REPAIRED WITHOUT COST TO THE OWNER.
 - THE CONTRACTOR SHALL GUARANTEE MAINTENANCE OF EQUIPMENT. THE OWNER SHALL ACCEPT FULL RESPONSIBILITY FOR PROPER OPERATION AND MAINTENANCE OF EQUIPMENT IMMEDIATELY UPON SUBSTANTIAL COMPLETION AND OCCUPANCY OF THE BUILDING.
 - FINAL ACCEPTANCE BY THE OWNER WILL NOT OCCUR UNTIL ALL OPERATING INSTRUCTIONS AND LIMITS ON EQUIPMENT SETTINGS AND OPERATING PERSONNEL THOROUGHLY INDOCTRINATED IN THE OPERATION OF ALL ELECTRICAL EQUIPMENT BY THE CONTRACTOR.
- OPERATION AND MAINTENANCE MANUALS
 - OPERATION AND MAINTENANCE MANUALS (O&M MANUALS) SHALL CONTAIN:
 - NAMES AND CONTACT INFORMATION FOR THE PROJECT ARCHITECT, PROJECT ENGINEER.
 - NAMES AND CONTACT INFORMATION FOR THE GENERAL CONTRACTOR OR CONSTRUCTION MANAGER.
 - NAMES AND CONTACT INFORMATION FOR SUB-CONTRACTORS.
 - INSTALLATION, MAINTENANCE AND OPERATING INSTRUCTIONS FOR EACH PIECE OF EQUIPMENT.
 - PARTS LISTS.
 - WIRING DIAGRAMS.
 - EQUIPMENT START-UP AND INSPECTION CERTIFICATES.
 - TEST AND BALANCE REPORTS.
 - COMMISSIONING REPORTS.
 - COPIES OF EQUIPMENT WARRANTIES.
 - COPIES OF SUBMITTALS.
 - RECORD DRAWINGS.
 - PRIOR TO SUBSTANTIAL COMPLETION SUBMIT AN ELECTRONIC COPY OF THE O&M MANUAL IN PDF FORMAT TO THE ARCHITECT, ENGINEER AND OWNER FOR REVIEW AND APPROVAL. THE PDF SHALL BE ONE FILE WITH AN INDEX AND HYPERLINKS TO EACH SECTION. INDIVIDUAL BOUND PDFS WITHOUT AUTOMATED NAVIGATION WILL BE REJECTED. ALL O&M DATA SHALL BE GROUPED BY THE EQUIPMENT TYPE AND ORDERED BY THE SPECIFICATION NUMBERING.
 - PRIOR TO FINAL PAYMENT A FINAL ELECTRONIC COPY OF THE O&M MANUAL ON AN ARCHIVAL QUALITY DVD AS WELL AS TWO PRINTED COPIES SHALL BE FURNISHED TO THE OWNER. PRINTED COPIES SHALL HAVE COMMERCIAL QUALITY 8-1/2" X 11" 3-RING BINDERS WITH TABBED DIVIDERS FOR EACH SECTION.
- CLEAN-UP AND COMMISSIONING
 - DURING CONSTRUCTION - THROUGHOUT CONSTRUCTION, KEEP WORK AREA REASONABLY NEAT AND ORDERLY BY PERIODIC CLEAN-UPS.
 - COMMISSIONING - AS INDEPENDENT PARTS OF CONSTRUCTION ARE COMPLETED, THEY MAY BE COMMISSIONED AND UTILIZED DURING CONSTRUCTION. SEE VARIOUS SECTIONS FOR RESTRICTIONS.
 - AT COMPLETION OF WORK
 - CLEAN EQUIPMENT OF DIRT AND DEBRIS, INCLUDING INTERIOR OF PANELS, OUTLET BOXES, ETC. REMOVE LABELS FROM AND CLEAN ALL FIXTURE LENSES.
 - REMOVE MATERIALS, SCRAPS, ETC., RELATIVE TO THIS WORK AND LEAVE PREMISES IN CLEAN AND ORDERLY CONDITION. THIS INCLUDES ALL TUNNELS, ATTICS, CEILING AND CRAWL SPACES.
 - REMOVE ALL TEMPORARY FACILITIES AND RESTORE TO CONDITIONS PRESENT PRIOR TO WORK.

- J. PROJECT COMPLETION AND DEMONSTRATION**
- TESTING
 - PRIOR TO FINAL TEST, ALL SWITCHES, PANELBOARDS, DEVICES, AND FIXTURES SHALL BE IN PLACE.
 - AT COMPLETION OF WORK, OR UPON REQUEST FROM ARCHITECT/ENGINEER, PLACE ENTIRE ELECTRICAL INSTALLATION, AND/OR ANY PORTION THEREOF, IN OPERATION TO DEMONSTRATE SATISFACTORY OPERATION.
 - ALL ELECTRICAL SYSTEMS SHALL BE FREE FROM SHORT CIRCUITS AND UNINTENTIONAL GROUNDS.
 - FURNISH ONE (1) COPY OF CERTIFIED TEST RESULTS TO ARCHITECT/ENGINEER PRIOR TO FINAL INSPECTION AND INCLUDE ONE (1) COPY IN EACH BROCHURE OF EQUIPMENT.
 - ADJUSTMENTS
 - IMMEDIATELY CORRECT ALL DEFICIENCIES WHICH ARE EVIDENCED DURING TESTS AND REPEAT TEST UNTIL SYSTEMS ARE APPROVED. DO NOT COVER OR CONCEAL ELECTRICAL INSTALLATIONS UNTIL SATISFACTORY TESTS ARE MADE AND APPROVED.
 - FINAL WALK-THRU
 - CONDUCT OPERATING TESTS DURING FINAL INSPECTION. DEMONSTRATE INSTALLATION TO OPERATE SATISFACTORILY IN ACCORDANCE WITH REQUIREMENTS OF CONTRACT DOCUMENTS. SHOULD ANY PORTION OF INSTALLATION FAIL TO MEET REQUIREMENTS OF CONTRACT DOCUMENTS, REPAIR OR REPLACE ITEMS FAILING TO MEET REQUIREMENTS UNTIL ITEMS CAN BE DEMONSTRATED TO COMPLY.
 - HAVE INSTRUMENTS AVAILABLE FOR MEASURING LIGHT INTENSITIES, VOLTAGE AND CURRENT VALUES AND FOR DEMONSTRATION OF CONTINUITY, GROUNDS, OR OPEN CIRCUIT CONDITIONS.
 - FURNISH PERSONNEL TO ASSIST IN TAKING MEASUREMENTS AND MAKING TESTS. IN EVENT THAT SYSTEMS ARE NOT COMPLETE AND FULLY OPERATIONAL AT TIME OF FINAL INSPECTION, ALL COSTS OF ANY SUBSEQUENT INSPECTIONS SHALL BE BORNE BY CONTRACTOR AT NO ADDITIONAL COST TO OWNER.
 - OWNER ORIENTATION AND TRAINING
 - GENERAL
 - THE SYSTEM TRAINING IS INTENDED TO FAMILIARIZE THE OWNER'S OPERATING AND MAINTENANCE STAFF WITH ALL SYSTEMS REQUIRING MAINTENANCE. TRAINING IS TO BE PROVIDED AFTER THE SYSTEMS ARE IN PLACE AND OPERATIONAL, AFTER ISSUES NOTED DURING COMMISSIONING HAVE BEEN RESOLVED, AND BEFORE FINAL ACCEPTANCE.
 - ATTENDANCE - TRAINING IS TO BE PROVIDED BY CONTRACTOR'S REPRESENTATIVES THAT ARE FAMILIAR WITH THE SYSTEM'S OPERATION AND MAINTENANCE REQUIREMENTS. INDIVIDUAL TRAINING SESSIONS (MODULES) ARE TO PROVIDED FOR EACH TYPE OR GROUP OF SYSTEMS, SEPARATED ROUGHLY BY TRADE GROUP THAT WILL BE PERFORMING MAINTENANCE ON THE SYSTEM.
 - SCHEDULE - DUPLICATE TRAINING SESSIONS ARE TO BE PROVIDED FOR EACH TRADE GROUP. TRAINING SHALL BE PROVIDED FOR PERSONNEL THAT WILL BE SCHEDULED ON DIFFERENT DATES. LENGTH OF TRAINING SESSIONS WILL BE DETERMINED BY SCOPE OF TRAINING INDICATED BELOW, AND AS COORDINATED WITH OWNER AFTER DRAFT COPY OF TRAINING DOCUMENTS HAVE BEEN REVIEWED.
 - TRAINING DOCUMENTATION
 - CONTRACTOR TO SUBMIT DRAFT COPY OF AGENDA AND TRAINING DOCUMENTS TO OWNER FOR REVIEW AT LEAST TWO WEEKS PRIOR TO TRAINING DATE.
 - PROVIDE A COPY OF THE FOLLOWING ITEMS FOR EACH PERSON THAT WILL BE ATTENDING THE TRAINING SESSIONS. COORDINATE REQUIRED NUMBER WITH THE OWNER.
 - TRAINING AGENDA.
 - SUMMARY OF NEW SYSTEMS AND EXISTING SYSTEMS AFFECTED BY THIS PROJECT.
 - SUMMARY OF WORK PERFORMED UNDER THIS PROJECT.
 - CONTROL SYSTEM DRAWINGS AND SEQUENCES OF OPERATION.
 - LIST OF IMPORTANT MAINTENANCE AND TROUBLE-SHOOTING OPERATIONS FOR ALL SYSTEMS.
 - TRAINING SESSIONS
 - ASSEMBLE AT LOCATION TO BE DETERMINED BY THE OWNER.
 - DISTRIBUTE TRAINING DOCUMENTATION AS INDICATED ABOVE.
 - PROVIDE CLASSROOM STYLE TRAINING IF REQUIRED FOR ORIENTATION. DISCUSSION OF NEW SYSTEMS AND EXISTING SYSTEMS AFFECTED BY THIS PROJECT, AND OTHER ISSUES APPROPRIATE FOR A CLASSROOM FORMAT.
 - VISIT SITE AND REVIEW LOCATIONS, AND PERFORM DETAILED REVIEW OF OPERATION AND MAINTENANCE REQUIREMENTS FOR CURRENT SYSTEMS.

260505 - SELECTIVE DEMOLITION OF ELECTRICAL SYSTEMS

- NOT ALL REMOVAL AND REVISION WORK REQUIRED AS PART OF THE DEMOLITION WORK IS SHOWN ON THE PLANS. THE PLANS ARE INTENDED TO INDICATE AREAS WHERE DEMOLITION WILL OCCUR AND TO ESTABLISH THE INTENT OF THE DEMOLITION WORK. IT IS THE CONTRACTOR'S RESPONSIBILITY TO REMOVE ALL EXISTING ELECTRICAL RACEWAYS, WIRES, DEVICES AND EQUIPMENT THAT FALL WITHIN THE AREA AFFECTED BY DEMOLITION OF THE STRUCTURE.
- THE CONTRACTOR SHALL THOROUGHLY FAMILIARIZE HIMSELF WITH WORK AND LOCAL CONDITIONS UNDER WHICH THE WORK IS TO BE PERFORMED. USING ORIGINAL DESIGN DRAWINGS AND WALK-THROUGH INSPECTIONS, A CONCERTED EFFORT WAS MADE TO PLACE PERTINENT INFORMATION ON THE CONTRACT DRAWINGS. HOWEVER, DUE TO THE NATURE OF DEMO/REMODEL WORK, THE CONTRACTOR MUST BEAR IN MIND THAT UNFORESEEN CONDITIONS MAY EXIST, AND SHALL THOROUGHLY INSPECT THE WORK AREA PRIOR TO HIS BID. THE CONTRACTOR SHALL INCLUDE IN HIS BID ANY/ALL INCIDENTAL ITEMS WHICH MAY BE REQUIRED TO PROVIDE COMPLETE DEMOLITION AND REWORK ASSOCIATED SYSTEMS IN ADJACENT AREAS WHERE NO DEMOLITION IS OCCURRING.
- PROVIDE TEMPORARY WIRING AND CONNECTIONS TO MAINTAIN EXISTING SYSTEMS IN SERVICE DURING CONSTRUCTION. WHEN WORK MUST BE PERFORMED ON ENERGIZED EQUIPMENT OR CIRCUITS, USE PERSONNEL EXPERIENCED IN SUCH OPERATIONS AND FOLLOW THE SAFE WORKING PRACTICE REQUIREMENTS OF NFPA 70E.
- INVENTORY AND RECORD, BY USE OF PRECONSTRUCTION PHOTOGRAPHS OR VIDEO, THE CONDITION OF ITEMS TO BE REMOVED AND SALVAGED. PROVIDE PHOTOGRAPHS OR VIDEO OF CONDITIONS THAT MIGHT BE MISCONSTRUED AS DAMAGE TO EXISTING SYSTEMS OR EQUIPMENT.
- OBTAIN PERMISSION FROM THE OWNER AT LEAST [72] HOURS PRIOR TO PARTIALLY OR COMPLETELY DISABLING THE ELECTRICAL SYSTEM. MINIMIZE THE DURATION OF ANY OUTAGES. IF REQUIRED, MAKE TEMPORARY CONNECTIONS TO MAINTAIN SERVICE IN AREAS ADJACENT TO THE DEMOLITION WORK AREA.
- REMOVE ALL ELECTRICAL DEVICES FROM WALLS, FLOORS AND CEILINGS THAT ARE TO BE DEMOLISHED OR MOVED. REMOVE ABANDONED OUTLETS IF CONDUIT AND WIRING SERVICING THEM IS ABANDONED AND REMOVED. PROVIDE BLANK COVER FOR ANY ABANDONED BOXES WHICH ARE NOTED ON THE PLANS AS NOT REMOVED. REMOVE CONDUIT TO POINT WHERE IT NO LONGER INTERFERES WITH CONSTRUCTION AND IS CONCEALED. FOR CONDUIT BURIED IN CONCRETE OR CMU REMOVE ALL ELECTRICAL CONDUIT OFF FLUSH WITH FLOOR AND PLUG CONDUIT. REMOVE ALL CONDUCTORS BACK TO SOURCE (PANELBOARD OR LAST LIVE DEVICE).
- MAINTAIN ACCESS TO EXISTING ELECTRICAL INSTALLATIONS THAT REMAIN ACTIVE. MODIFY INSTALLATION OR PROVIDE ACCESS PANEL AS REQUIRED.
- PROVIDE REVISED TYPED CIRCUIT DIRECTORY IN PANELBOARDS THAT HAVE BEEN REVISED.
- REPAIR ADJACENT CONSTRUCTION AND FINISHES DAMAGED DURING DEMOLITION AND EXTENSION WORK.
- EQUIPMENT TO BE RELOCATED SHALL BE SERVICED, MODIFIED AND REPAIRED AS NECESSARY TO PLACE IT IN GOOD WORKING ORDER AND TO THE SATISFACTION OF THE OWNER. AND OF FRESH MATERIALS NECESSARY TO MAKE IT FUNCTIONAL FOR USE AT THE NEW LOCATION. EQUIPMENT SHALL BE TESTED IN THE NEW LOCATION AND PROPER FUNCTION DEMONSTRATED.
- EXCEPT FOR ITEMS OR MATERIALS INDICATED TO BE RECYCLED, REUSED, SALVAGED, REINSTALLED, OR OTHERWISE INDICATED TO REMAIN OWNER'S PROPERTY, REMOVE DEMOLISHED MATERIALS FROM PROJECT SITE AND LEGALLY DISPOSE OF THEM IN AN EPA-APPROVED LANDFILL. DO NOT ALLOW DEMOLISHED MATERIALS TO ACCUMULATE ON-SITE. REMOVE AND TRANSPORT DEBRIS IN A MANNER THAT WILL PREVENT SPILLAGE ON ADJACENT SURFACES AND AREAS.
- HANDLING OF BALLASTS WITH PCBs - GENERALLY, ALL HIGH POWER FACTOR FLUORESCENT LIGHTING BALLASTS, AND SOME HID BALLASTS, THAT WERE MANUFACTURED BEFORE 1978 CONTAIN POLYCHLORINATED BIPHENYL (PCB) COMPOUNDS IN THEIR CAPACITORS. FOR BALLASTS OF THIS VINTAGE, IF THE PCB CONTENT IS NOT STATED ON THE BALLAST LABEL, THE BALLAST SHALL BE HANDLED AS A PCB BALLAST. SUCH BALLASTS SHALL BE HANDLED PER EPA AND DNR PCB REGULATIONS.

260533 - RACEWAYS AND BOXES FOR ELECTRICAL SYSTEMS

- MINIMUM RACEWAY SIZE: 1 INCH TRADE SIZE FOR TELECOM/DATA AND 3/4 INCH TRADE SIZE FOR ALL OTHER APPLICATIONS.
- INSTALL NONMETALLIC CONDUIT OR TUBING FOR PROTECTING BARE GROUNDING CONDUCTORS.
- DO NOT INSTALL RACEWAYS OR ELECTRICAL ITEMS ON ANY "EXPLOSION-RELIEF" WALLS OR ROTATING EQUIPMENT.
- DO NOT FASTEN CONDUITS ONTO THE BOTTOM SIDE OF A METAL DECK FLOOR.
- KEEP RACEWAYS AT LEAST 6 INCHES AWAY FROM PARALLEL RUNS OF FLUES AND STEAM OR HOT-WATER PIPES. INSTALL HORIZONTAL RACEWAY RUNS ABOVE WATER AND STEAM PIPING.
- INSTALL NO MORE THAN THE EQUIVALENT OF THREE 90-DEGREE BENDS IN ANY CONDUIT RUN EXCEPT FOR CONTROL WIRING CONDUITS, FOR WHICH FEWER BENDS ARE ALLOWED. SUPPORT WITHIN 12 INCHES OF CHANGES IN DIRECTION. SUPPORT CONDUIT WITHIN 12 INCHES OF ENCLOSURES TO WHICH IT IS CONNECTED.
- UNLESS BURIED, INSTALL ALL CONDUITS PARALLEL OR PERPENDICULAR TO BUILDING LINES.
- INSTALL RACEWAYS SQUARE TO THE ENCLOSURE AND TERMINATE AT ENCLOSURES WITH LOCKNUTS. INSTALL LOCKNUTS HAND TIGHT PLUS 1/4 TURN MORE. DO NOT RELY ON LOCKNUTS TO PENETRATE NONCONDUCTIVE COATINGS ON ENCLOSURES. REMOVE COATINGS IN THE LOCKNUT AREA PRIOR TO ASSEMBLING CONDUIT TO ENCLOSURE TO ENSURE A CONTINUOUS GROUND PATH.
- INSTALL FIRESTOPPING AT PENETRATIONS OF FIRE-RATED FLOOR AND WALL ASSEMBLIES.
- INDOOR RACEWAYS:
 - EXPOSED, NOT SUBJECT TO PHYSICAL DAMAGE: EMT.
 - EXPOSED AND SUBJECT TO SEVERE PHYSICAL DAMAGE: RIGID STEEL CONDUIT.
 - CONCEALED IN NEW CEILINGS AND INTERIOR WALLS AND PARTITIONS: EMT.
 - CONNECTION TO VIBRATING EQUIPMENT (INCLUDING TRANSFORMERS AND HYDRAULIC, PNEUMATIC, ELECTRIC SOLENOID, OR MOTOR-DRIVEN EQUIPMENT): FMC, EXCEPT USE LFMC IN DAMP OR WET LOCATIONS.
 - DAMP OR WET LOCATIONS: RIGID STEEL CONDUIT.
 - BOXES AND ENCLOSURES: NEMA 250, TYPE 1, EXCEPT USE NEMA 250, TYPE 3R, NONMETALLIC IN DAMP OR WET LOCATIONS.
 - RACEWAY FITTINGS: COMPATIBLE WITH RACEWAYS AND SUITABLE FOR USE AND LOCATION.
 - RIGID AND INTERMEDIATE STEEL CONDUIT: USE THREADED RIGID STEEL CONDUIT FITTINGS, UNLESS NOTED OTHERWISE.
 - INSTALL SURFACE RACEWAYS ONLY WHERE SPECIFICALLY INDICATED ON DRAWINGS. INSTALL SURFACE RACEWAY WITH A MINIMUM 2-INCH RADIUS CONTROL AT BEND POINTS.
 - FLEXIBLE CONDUIT CONNECTIONS: MAXIMUM OF 72 INCHES OF FLEXIBLE CONDUIT FOR RECESSED AND SEMI-RECESSED LUMINAIRES. EQUIPMENT SUBJECT TO VIBRATION, NOISE TRANSMISSION, OR MOVEMENT; AND FOR TRANSFORMER AND MOTOR LOCATIONS. USE FMC FOR DAMP OR WET LOCATIONS SUBJECT TO SEVERE PHYSICAL DAMAGE. USE LFMC OR LFMC IN DAMP OR WET LOCATIONS NOT SUBJECT TO SEVERE PHYSICAL DAMAGE.
- ENCLOSURES - BOXES AND ENCLOSURES FOR PANELBOARD, DISCONNECT SWITCH AND MOTOR CONTROL UNITS, ETC. BASED ON THE INSTALLATION LOCATIONS/ENVIRONMENTS.
 - INDOOR, DRY AND CLEAN LOCATIONS: NEMA 250, TYPE 1.
 - OUTDOOR LOCATIONS: NEMA 250, TYPE 3R.
 - KITCHEN WASH-DOWN AREAS: NEMA 250, TYPE 4X, STAINLESS STEEL.
 - OTHER WET OR DAMP, INDOOR LOCATIONS: NEMA 250, TYPE 4.
 - INDOOR LOCATIONS SUBJECT TO DUST, FALLING DIRT, AND DRIPPING NONCORROSIVE LIQUIDS: NEMA 250, TYPE 12.
 - HAZARDOUS AREAS INDICATED ON DRAWINGS: NEMA 250, TYPE 7TYPE 9 WITH COVER ATTACHED BY TYPE 316 STAINLESS STEEL BOLTS.
- GENERAL BOX MOUNTING
 - MOUNT BOXES AT HEIGHTS INDICATED ON DRAWINGS. IF MOUNTING HEIGHTS OF BOXES ARE NOT INDICATED, GIVE PREFERENCE TO ADA REQUIREMENTS. INSTALL BOXES WITH HEIGHT MEASURED TO CENTER OF BOX UNLESS OTHERWISE INDICATED.
 - HORIZONTALLY SEPARATE BOXES MOUNTED ON OPPOSITE SIDES OF WALL SO THEY ARE NOT IN THE SAME VERTICAL CHANNEL.
 - LOCATE BOXES SO THAT COVER OR PLATE WILL NOT SPAN DIFFERENT BUILDING FINISHES.
 - FASTEN JUNCTION AND PULL BOXES TO OR SUPPORT FROM BUILDING STRUCTURE. DO NOT SUPPORT BOXES BY CONDUITS.

260519 - CONDUCTORS

- BRANCH CIRCUITS: COPPER, TYPE THHN/THWN-2, SOLID FOR NO. 10 AWG AND SMALLER; STRANDED FOR NO. 8 AWG AND LARGER. SINGLE CONDUCTORS IN RACEWAY.
- PROVIDE A DEDICATED NEUTRAL CONDUCTOR FOR EACH 120 V BRANCH CIRCUIT.

260526 - GROUNDING AND BONDING

- EQUIPMENT GROUND CONDUCTOR: COPPER WITH GREEN INSULATION (LARGER WIRES MAY BE PERMANENTLY MARKED WITH GREEN), SIZED PER NEC 250.122. DO NOT RELY ON CONDUIT FOR THE GROUNDING PATH.

260563 - IDENTIFICATION FOR ELECTRICAL SYSTEMS

- CONDUCTOR COLOR-CODING:
 - 208Y/120V; PHASE A - BLACK, PHASE B - RED, PHASE C - BLUE, NEUTRAL - WHITE.
 - GROUND: BARE COPPER OR GREEN.
- ALL EQUIPMENT SHALL HAVE AN IDENTIFICATION LABEL. BLACK LETTERS ON A WHITE FIELD. LABEL INCLUDES DEVICE UNIT NAME AND CIRCUIT THAT FEEDS IT.
 - 1/4" MINIMUM HEIGHT LETTERS FOR DISCONNECT SWITCHES AND MOTOR STARTERS.
 - 1/8" MINIMUM HEIGHT LETTERS FOR DEVICE COVERPLATES.

262726 - WIRING DEVICES

- TOGGLE SWITCHES - 120/277V, 20A. COMPLY WITH NEMA WD 1, UL 20, AND FS W-5-896.
 - COPPER, AH1221 (SINGLE-POLE), AH1222 (TWO-POLE), AH1223 (THREE-WAY), AH1224 (FOUR-WAY).
 - HUBBELL: HBL1221 (SINGLE-POLE), HBL1222 (TWO-POLE), HBL1223 (THREE-WAY), HBL1224 (FOUR-WAY).
 - LEVITON: 1221-2 (SINGLE-POLE), 1222-2 (TWO-POLE), 1223-2 (THREE-WAY), 1224-2 (FOUR-WAY).
 - P&S: CSB20AC1 (SINGLE-POLE), CSB20AC2 (TWO-POLE), CSB20AC3 (THREE-WAY), CSB20AC4 (FOUR-WAY).
- WALL-BOX DIMMERS (FOR SCREW-IN LED LAMPS WITH INTEGRAL DRIVERS) - MODULAR, FULL-WAVE, SOLID-STATE UNITS WITH INTEGRAL, QUIET ON-OFF SWITCHES AND AUDIBLE FREQUENCY AND EMIRF SUPPRESSION FILTERS. MATCH DIMMER TO LAMP(S) BEING DIMMED IN ACCORDANCE WITH MANUFACTURER'S GUIDELINES. DEMONSTRATE CONSISTENT, PROPER FUNCTION WITH LAMP. INSTALL ALL HOT, SWITCHED, TRAVELERS, NEUTRAL AND GROUND WIRES AS REQUIRED, AS WELL AS LOW-VOLTAGE WIRES.
 - PHILIPS: SUNRISER SERIES (LT1203261).
 - WATT STOPPER, RADIANT SERIES (RH4FBL3P).
 - ACUITY: SYNGRY SERIES (ISD-BC).
 - LUTRON: DVA SERIES (DVSTV).
- WALL-BOX DIMMER (FOR SCREW-IN LED LAMPS WITH INTEGRAL DRIVERS) - MODULAR, FULL-WAVE, SOLID-STATE UNITS WITH INTEGRAL, QUIET ON-OFF SWITCHES AND AUDIBLE FREQUENCY AND EMIRF SUPPRESSION FILTERS. MATCH DIMMER TO LAMP(S) BEING DIMMED IN ACCORDANCE WITH MANUFACTURER'S GUIDELINES. DEMONSTRATE CONSISTENT, PROPER FUNCTION WITH LAMP. INSTALL ALL HOT, SWITCHED, TRAVELERS, NEUTRAL AND GROUND WIRES AS REQUIRED.
 - WATTSOPPER, RADIANT TRU-UNIVERSAL SERIES (RH703PTU).
- DEVICE COLOR - AS SELECTED BY ARCHITECT UNLESS OTHERWISE INDICATED OR REQUIRED BY NFPA 70 OR DEVICE LISTING.
- WALL PLATES
 - INDOOR FINISHED AREAS - STAINLESS STEEL, TO MATCH EXISTING WITHIN SPACE.
- IDENTIFICATION - IDENTIFY PANELBOARD AND CIRCUIT NUMBER FROM WHICH THE DEVICE IS SERVED.
 - MARK INSIDE OF BOX OR COVERPLATE WITH PERMANENT MARKER. TEST TO ENSURE THAT MARKER LINES ARE NOT VISIBLE ON OUTSIDE OF COVER WHEN IT IS INSTALLED.
 - MARK OUTSIDE OF COVERPLATE USING LABELER SUCH AS BROTHER PT-90 TO PRODUCE 1/8" BLACK LETTERS (WHITE LETTERS IF COVER IS DARK) ON CLEAR TAPE.
- WEATHER STRIPPING - BEHIND EXTERIOR WALL DEVICES INSTALL A PRECUT FOAM INSULATION PAD OVER THE FIXTURE AND REINSTALL THE COVER.

265110 - LED LIGHTING

- GENERAL - ALL FIXTURES SHALL HAVE LED LIGHT SOURCES UNO.
 - INTERNAL, FACTORY INSTALLED BALLAST/DRIVER UNO.
 - DIMMABLE FROM 100% TO 10% OF MAXIMUM LIGHT OUTPUT.
 - NOMINAL OPERATING VOLTAGE, AS NOTED ON THE PLANS.
 - LENS THICKNESS, AT LEAST 0.125 INCH MINIMUM UNO.
 - INDOOR FIXTURES: MINIMUM CRI OF 80 UNO.
- LED ASSEMBLIES - UL RATED FOR 40 DEGREE C AMBIENT ENVIRONMENTS, 50,000 HOUR FIXTURE LIFE, INCLUDING DRIVER, 5 YEAR WARRANTY AND COMPLIANT WITH IESNA LM-79 AND LM-80 STANDARDS.
- STANDARDS - UNO, COMPLY WITH THE FOLLOWING:
 - ENERGY STAR OR DESIGN LIGHTS CONSORTIUM (DLC) CERTIFIED.
 - NRTL COMPLIANCE: LUMINAIRES FOR HAZARDOUS LOCATIONS SHALL BE LISTED AND LABELED FOR INDICATED CLASS AND DIVISION OF HAZARD BY AN NRTL.
 - UL LISTING: LISTED FOR DAMP AND/OR WET LOCATIONS AS REQUIRED.
 - RECESSED LUMINAIRES SHALL COMPLY WITH NEMA LE 4.
- FIRE RATED ASSEMBLIES: FIXTURES INSTALLED IN FIRE RATED ASSEMBLIES SHALL MAINTAIN THE FIRE RATING OF SAID ASSEMBLY. CONTRACTOR IS REQUIRED TO COORDINATE WITH ARCHITECTURAL DRAWINGS TO VERIFY ASSEMBLY RATINGS.
- INSULATED CEILING SPACE: FIXTURES INSTALLED IN AN INSULATED CEILING SHALL BE IC RATED AND HAVE MANUFACTURER RECOMMENDED CLEARANCES BETWEEN FIXTURE AND INSULATION. CONTRACTOR IS REQUIRED TO COORDINATE WITH ARCHITECTURAL DRAWINGS TO VERIFY INSULATED AREAS ABOVE CEILINGS.

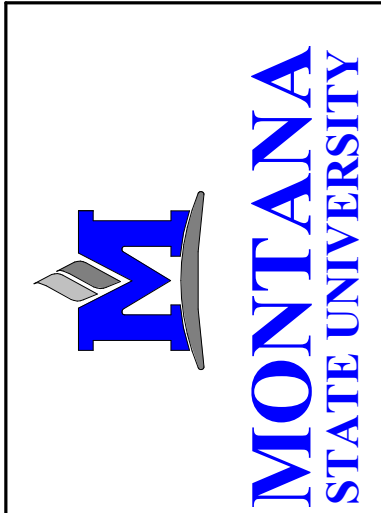

MSU-CPDC
MONTANA STATE UNIVERSITY
BOZEMAN, MONTANA
PHONE: 406.994.5413
FAX: 406.994.5605

**VISUAL COMMUNICATIONS
DARKROOMS 135 & 138 SINK
REPLACEMENT**
MONTANA STATE UNIVERSITY

BID SET



DRAWN BY: **SAJ**
REVIEWED BY: **RPM**

REV.	DESCRIPTION	DATE

PPA#20-0006
A/E#23061.01
MMI#6161.011

**SHEET TITLE
ELECTRICAL
SPECIFICATIONS**

**SHEET
E002**

**DATE
04-25-2024**

DRAWN BY:	SAJ	
REVIEWED BY:	RPM	
REV.	DESCRIPTION	DATE

PPA#20-0006
A/E#23061.01
MMI#6161.011

SHEET TITLE
ELECTRICAL
DEMOLITION PLAN

SHEET
E100

DATE
04-25-2024

ELECTRICAL DEMO NOTES

- A. IT IS ABSOLUTELY NECESSARY FOR ALL TRADES INVOLVED TO COORDINATE WITH EACH OTHER AND VERIFY THAT THERE ARE NO CONFLICTS IN LOCATION OF DUCTS, CONDUITS, DIFFUSERS, BOXES, AND OTHER ITEMS THROUGHOUT THIS PROJECT BEFORE FINAL PLACEMENT OF MATERIALS.
- B. ELECTRICAL CONTRACTOR IS RESPONSIBLE FOR ALL CUTTING OF FLOORS, WALLS, CEILINGS, AND ROOFS TO PERFORM THE REQUIRED WORK DEPICTED IN THESE DOCUMENTS. THE CONTRACTOR IS RESPONSIBLE FOR ALL PATCHING OF HOLES TO THE SATISFACTION OF THE ARCHITECT/ENGINEER.
- C. ALL WALL REGIONS SHOWN DASHED ARE EXISTING, TO BE DEMO'D, OR IN SOME CASES ARE EXISTING DOORWAYS TO BE WALLED IN. CONTRACTOR SHALL FIELD-VERIFY AFFECTED POWER, LIGHTING AND SIGNAL, PRIOR TO BID.
- D. DASHED WALLS, EQUIPMENT, FIXTURES AND DEVICES SHOWN BLACK, OR BLACK, DASHED, AND DENOTED WITH '(D)' ARE EXISTING FOR DEMO, AND ITEMS IN GRAY AND SOLID ARE EXISTING TO REMAIN, UNLESS SPECIFICALLY NOTED OTHERWISE.
- E. ALL ITEMS NOTED FOR DEMO SHALL BE COMPLETELY DEMO'D, INCLUDING DISCONNECTS, CONDUIT AND CONDUCTORS BACK TO SOURCE, UNLESS SPECIFICALLY NOTED OTHERWISE.
- F. NOT ALL EXISTING DEVICE LOCATIONS HAVE BEEN VERIFIED OR SHOWN ON THESE PLANS. THE CONTRACTOR SHALL FIELD-VERIFY EXISTING CONDITIONS, PRIOR TO BID.

KEY NOTES:

- 1. SALVAGE EXISTING CIRCUIT SERVING DEMOLISHED DARK LIGHTS WITHIN ROOM. SAVE FOR REUSE TO SERVE NEW DARK LIGHTS.

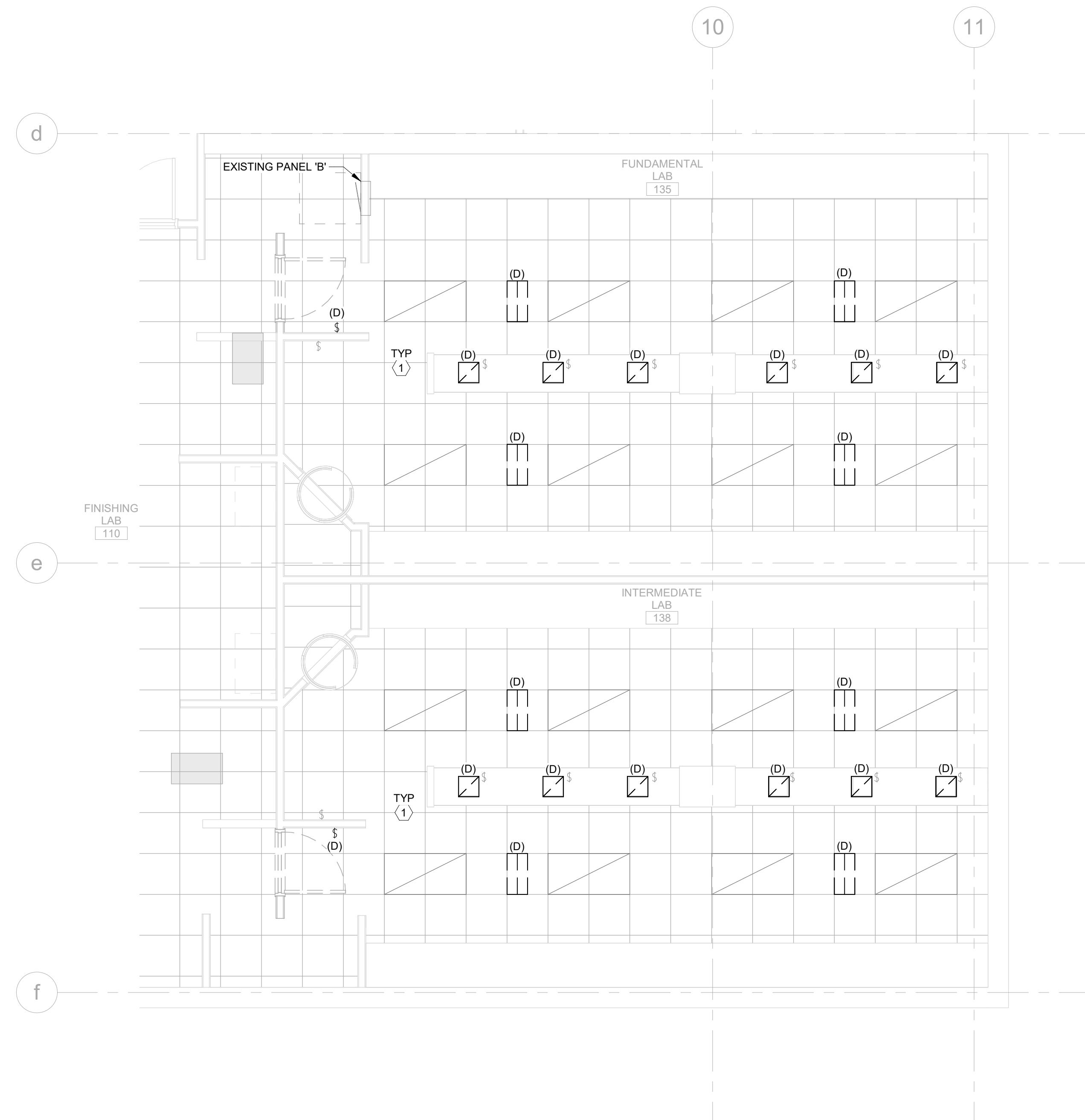

1 ELECTRICAL DEMOLITION PLAN
E100 1/4" = 1'-0"



DRAWN BY: SAJ		
REVIEWED BY: RPM		
REV.	DESCRIPTION	DATE

PPA#20-0006
A/E#23061.01
MMI#6161.011

SHEET TITLE
ELECTRICAL
RENOVATION PLAN

SHEET
E101

DATE
04-25-2024

ELECTRICAL GENERAL NOTES

- A. IT IS ABSOLUTELY NECESSARY FOR ALL TRADES INVOLVED TO COORDINATE WITH EACH OTHER AND VERIFY THAT THERE ARE NO CONFLICTS IN LOCATION OF DUCTS, CONDUITS, DIFFUSERS, BOXES, AND OTHER ITEMS THROUGHOUT THIS PROJECT BEFORE FINAL PLACEMENT OF MATERIALS.
- B. ELECTRICAL CONTRACTOR IS RESPONSIBLE FOR ALL CUTTING OF FLOORS, WALLS, CEILINGS, AND ROOFS TO PERFORM THE REQUIRED WORK DEPICTED IN THESE DOCUMENTS. THE CONTRACTOR IS RESPONSIBLE FOR ALL PATCHING OF HOLES TO THE SATISFACTION OF THE ARCHITECT/ENGINEER.
- C. LOW VOLTAGE CABLES (LIGHTING CONTROLS) ABOVE ACCESSIBLE CEILINGS SHALL BE SUPPORTED USING J-HOOKS AT INTERVALS NOT TO EXCEED 48" OC, UNO.

KEY NOTES:

- 1. PROVIDE 120V POWER CONNECTION FOR NEW ELECTRONIC MIXING VALVE (TV-1). COORDINATE WITH PLUMBING CONTRACTOR FOR EXACT LOCATION AND WIRE PER MANUFACTURER REQUIREMENTS.
- 2. UTILIZE AN EXISTING SPARE 20A-1P CIRCUIT BREAKER WITHIN PANEL FOR NEW 120V CIRCUIT SERVING THE TWO ELECTRONIC MIXING VALVES.
- 3. PROVIDE (2) NEW DIMMER SWITCHES FOR CONTROL OF THE TYPE B2 LUMINAIRES WITHIN ROOM. ONE DIMMER SWITCH SHALL CONTROL THE TYPE B2 RED LIGHT SOURCES, AND THE SECOND DIMMER SWITCH SHALL CONTROL THE TYPE B2 AMBER LIGHT SOURCES.
- 4. EXISTING HOOD-MOUNT ON/OFF ROCKER SWITCHES SHALL REMAIN AND SHALL CONTROL EACH INDIVIDUAL ASSOCIATED TYPE B1 LUMINAIRE.
- 5. CIRCUIT NEW B1 & B2 LUMINAIRES TO EXISTING 120V CIRCUIT SERVING DEMOLISHED LIGHTS. EXTEND EXISTING CIRCUIT TO NEW LUMINAIRES AS REQUIRED.

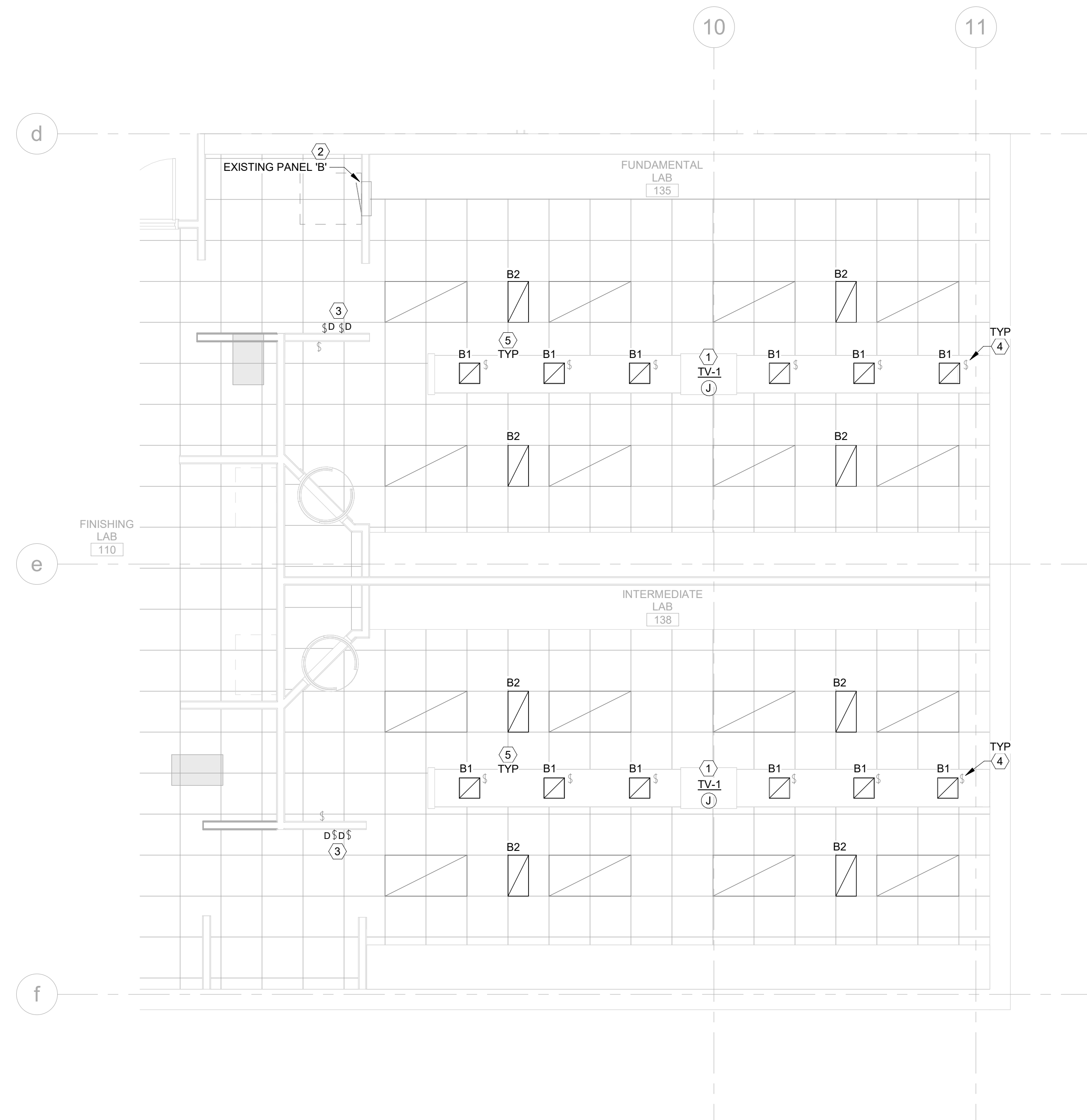

1
E101
ELECTRICAL RENOVATION PLAN
1/4" = 1'-0"

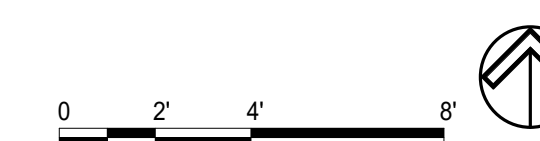

BID SET